

Chapter 15

Infrared Spectroscopy

C.-P. Sherman Hsu, Ph.D.

*Separation Sciences
Research and Product Development
Mallinckrodt, Inc.
Mallinckrodt Baker Division*

Summary

General Uses

- Identification of all types of organic and many types of inorganic compounds
- Determination of functional groups in organic materials
- Determination of the molecular composition of surfaces
- Identification of chromatographic effluents
- Quantitative determination of compounds in mixtures
- Nondestructive method
- Determination of molecular conformation (structural isomers) and stereochemistry (geometrical isomers)
- Determination of molecular orientation (polymers and solutions)

Common Applications

- Identification of compounds by matching spectrum of unknown compound with reference spectrum (fingerprinting)
- Identification of functional groups in unknown substances

- Identification of reaction components and kinetic studies of reactions
- Identification of molecular orientation in polymer films
- Detection of molecular impurities or additives present in amounts of 1% and in some cases as low as 0.01%
- Identification of polymers, plastics, and resins
- Analysis of formulations such as insecticides and copolymers

Samples

State

Almost any solid, liquid or gas sample can be analyzed. Many sampling accessories are available.

Amount

Solids 50 to 200 mg is desirable, but 10 μg ground with transparent matrix (such as KBr) is the minimum for qualitative determinations; 1 to 10 μg minimum is required if solid is soluble in suitable solvent.

Liquids 0.5 μL is needed if neat, less if pure.

Gases 50 ppb is needed.

Preparation

Little or no preparation is required; may have to grind solid into KBr matrix or dissolve sample in a suitable solvent (CCl_4 and CS_2 are preferred). Many types of sample holders and cells are available. Water should be removed from sample if possible.

Analysis Time

Estimated time to obtain spectrum from a routine sample varies from 1 to 10 min depending on the type of instrument and the resolution required. Most samples can be prepared for infrared (IR) analysis in approximately 1 to 5 min.

Limitations

General

- Minimal elemental information is given for most samples.
- Background solvent or solid matrix must be relatively transparent in the spectral region of interest.
- Molecule must be active in the IR region. (When exposed to IR radiation, a minimum of one vibrational motion must alter the net dipole moment of the molecule in order for absorption to be observed.)

Accuracy

In analysis of mixtures under favorable conditions, accuracy is greater than 1%. In routine analyses, it is $\pm 5\%$.

Sensitivity and Detection Limits

Routine is 2%; under most favorable conditions and special techniques, it is 0.01%.

Complementary or Related Techniques

- Nuclear magnetic resonance provides additional information on detailed molecular structure
- Mass spectrometry provides molecular mass information and additional structural information
- Raman spectroscopy provides complementary information on molecular vibration. (Some vibrational modes of motion are IR-inactive but Raman-active and vice versa.) It also facilitates analysis of aqueous samples. Cell window material may be regular glass.

Introduction

Infrared (IR) spectroscopy is one of the most common spectroscopic techniques used by organic and inorganic chemists. Simply, it is the absorption measurement of different IR frequencies by a sample positioned in the path of an IR beam. The main goal of IR spectroscopic analysis is to determine the chemical functional groups in the sample. Different functional groups absorb characteristic frequencies of IR radiation. Using various sampling accessories, IR spectrometers can accept a wide range of sample types such as gases, liquids, and solids. Thus, IR spectroscopy is an important and popular tool for structural elucidation and compound identification.

IR Frequency Range and Spectrum Presentation

Infrared radiation spans a section of the electromagnetic spectrum having wavenumbers from roughly 13,000 to 10 cm^{-1} , or wavelengths from 0.78 to 1000 μm . It is bound by the red end of the visible region at high frequencies and the microwave region at low frequencies.

IR absorption positions are generally presented as either wavenumbers (cm^{-1}) or wavelengths (μm). Wavenumber defines the number of waves per unit length. Thus, wavenumbers are directly proportional to frequency, as well as the energy of the IR absorption. The wavenumber unit (cm^{-1} , reciprocal centimeter) is more commonly used in modern IR instruments that are linear in the cm^{-1} scale. In the contrast, wavelengths are inversely proportional to frequencies and their associated energy. At present, the recommended unit of wavelength is μm (micrometers), but μ (micron) is used in some older literature. Wavenumbers and wavelengths can be interconverted using the following equation:

$$\text{Wavenumber (in } \text{cm}^{-1}\text{)} = \frac{1}{\text{Wavelength (in } \mu\text{m)}} \times 10^4 \quad (15.1)$$

IR absorption information is generally presented in the form of a spectrum with wavelength or wavenumber as the x-axis and absorption intensity or percent transmittance as the y-axis (Fig. 15.1).

Transmittance, T , is the ratio of radiant power transmitted by the sample (I) to the radiant power incident on the sample (I_0). Absorbance (A) is the logarithm to the base 10 of the reciprocal of the transmittance (T).

$$A = \log_{10}(1/T) = -\log_{10}T = -\log_{10}I/I_0 \quad (15.2)$$

The transmittance spectra provide better contrast between intensities of strong and weak bands because transmittance ranges from 0 to 100% T whereas absorbance ranges from infinity to zero. The analyst should be aware that the same sample will give quite different profiles for the IR spectrum, which is linear in wavenumber, and the IR plot, which is linear in wavelength. It will appear as if some IR bands have been contracted or expanded.

The IR region is commonly divided into three smaller areas: near IR, mid IR, and far IR.

Near IR

Mid IR

Far IR

Figure 15.1 IR spectra of polystyrene film with different x-axis units. (a) Linear in wavenumber (cm^{-1}), (b) linear in wavelength (μm). (Reprinted from R. M. Silverstein, G. C. Bassler, and T. C. Morrill, *Spectrometric Identification of Organic Compounds*, 4th edition. New York: John Wiley & Sons, 1981, p. 166, by permission of John Wiley & Sons, Inc., copyright © 1981.)

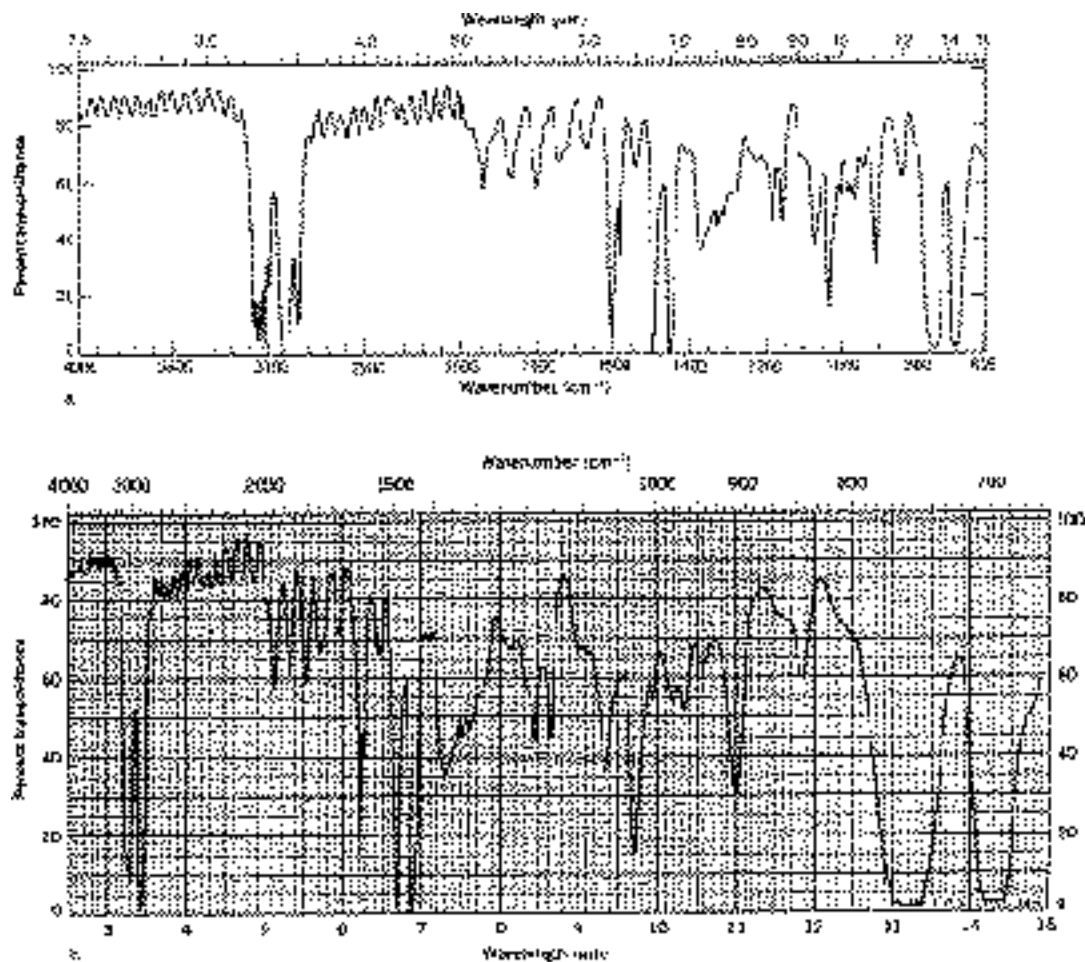

Wavenumber	13,000–4,000 cm^{-1}	4,000–200 cm^{-1}	200–10 cm^{-1}
Wavelength	0.78–2.5 μm	2.5–50 μm	50–1,000 μm

This chapter focuses on the most frequently used mid IR region, between 4000 and 400 cm^{-1} (2.5 to 25 μm). The far IR requires the use of specialized optical materials and sources. It is used for analysis of organic, inorganic, and organometallic compounds involving heavy atoms (mass number over 19). It provides useful information to structural studies such as conformation and lattice dynamics of samples. Near IR spectroscopy needs minimal or no sample preparation. It offers high-speed quantitative analysis without consumption or destruction of the sample. Its instruments can often be combined with UV-visible spectrometer and coupled with fiberoptic devices for remote analysis. Near IR spectroscopy has gained increased interest, especially in process control applications.

Theory of Infrared Absorption

At temperatures above absolute zero, all the atoms in molecules are in continuous vibration with respect to each other. When the frequency of a specific vibration is equal to the frequency of the IR radiation directed on the molecule, the molecule absorbs the radiation.

Each atom has three degrees of freedom, corresponding to motions along any of the three Cartesian coordinate axes (x , y , z). A polyatomic molecule of n atoms has $3n$ total degrees of freedom. However, 3 degrees of freedom are required to describe translation, the motion of the entire molecule through space. Additionally, 3 degrees of freedom correspond to rotation of the entire molecule. Therefore, the remaining $3n - 6$ degrees of freedom are true, fundamental vibrations for nonlinear molecules. Linear molecules possess $3n - 5$ fundamental vibrational modes because only 2 degrees of freedom are sufficient to describe rotation. Among the $3n - 6$ or $3n - 5$ fundamental vibrations (also known as normal modes of vibration), those that produce a net change in the dipole moment may result in an IR activity and those that give polarizability changes may give rise to Raman activity. Naturally, some vibrations can be both IR- and Raman-active.

The total number of observed absorption bands is generally different from the total number of fundamental vibrations. It is reduced because some modes are not IR active and a single frequency can cause more than one mode of motion to occur. Conversely, additional bands are generated by the appearance of overtones (integral multiples of the fundamental absorption frequencies), combinations of fundamental frequencies, differences of fundamental frequencies, coupling interactions of two fundamental absorption frequencies, and coupling interactions between fundamental vibrations and overtones or combination bands (Fermi resonance). The intensities of overtone, combination, and difference bands are less than those of the fundamental bands. The combination and blending of all the factors thus create a unique IR spectrum for each compound.

The major types of molecular vibrations are stretching and bending. The various types of vibrations are illustrated in Fig. 15.2. Infrared radiation is absorbed and the associated energy is converted into these type of motions. The absorption involves discrete, quantized energy levels. However, the individual vibrational motion is usually accompanied by other rotational motions. These combinations lead to the absorption bands, not the discrete lines, commonly observed in the mid IR region.

Figure 15.2 Major vibrational modes for a nonlinear group, CH₂. (+ indicates motion from the plane of page toward reader; - indicates motion from the plane of page away from reader.) (Reprinted from R. M. Silverstein, G. C. Bassler, and T. C. Morrill, *Spectrometric Identification of Organic Compounds*, 4th edition. New York: John Wiley & Sons, 1981, p. 166, by permission of John Wiley & Sons, Inc., copyright © 1981.)

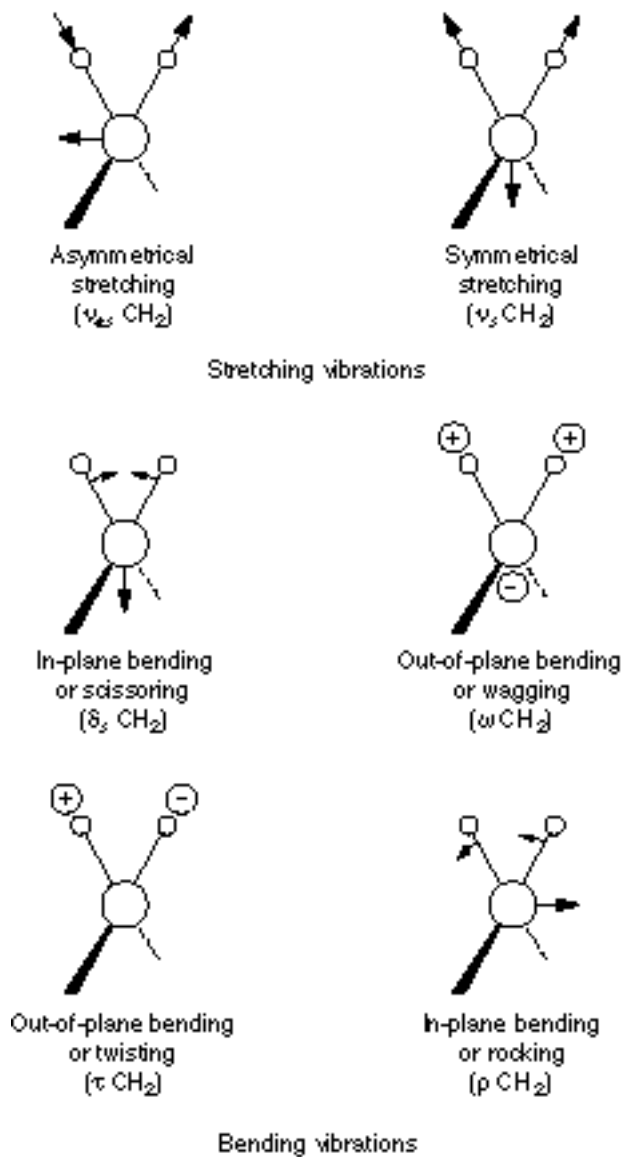

How It Works

In simple terms, IR spectra are obtained by detecting changes in transmittance (or absorption) intensity as a function of frequency. Most commercial instruments separate and measure IR radiation using dispersive spectrometers or Fourier transform spectrometers.

Dispersive Spectrometers

Dispersive spectrometers, introduced in the mid-1940s and widely used since, provided the robust instrumentation required for the extensive application of this technique.

Spectrometer Components

An IR spectrometer consists of three basic components: radiation source, monochromator, and detector. A schematic diagram of a typical dispersive spectrometer is shown in Fig. 15.3.

The common radiation source for the IR spectrometer is an inert solid heated electrically to 1000 to 1800 °C. Three popular types of sources are Nernst glower (constructed of rare-earth oxides), Globar (constructed of silicon carbide), and Nichrome coil. They all produce continuous radiations, but with different radiation energy profiles.

The monochromator is a device used to disperse a broad spectrum of radiation and provide a continuous calibrated series of electromagnetic energy bands of determinable wavelength or frequency range. Prisms or gratings are the dispersive components used in conjunction with variable-slit mechanisms, mirrors, and filters. For example, a grating rotates to focus a narrow band of frequencies on a mechanical slit. Narrower slits enable the instrument to better distinguish more closely spaced frequencies of radiation, resulting in better resolution. Wider slits allow more light to reach the detector and provide better system sensitivity. Thus, certain compromise is exercised in setting the desired slit width.

Most detectors used in dispersive IR spectrometers can be categorized into two classes: thermal detectors and photon detectors. Thermal detectors include thermocouples, thermistors, and pneumatic

Figure 15.3 Schematic diagram of a commercial dispersive IR instrument, the Perkin-Elmer Model 237B Infrared Spectrometer. (Reprinted by permission of the Perkin-Elmer Corporation.)

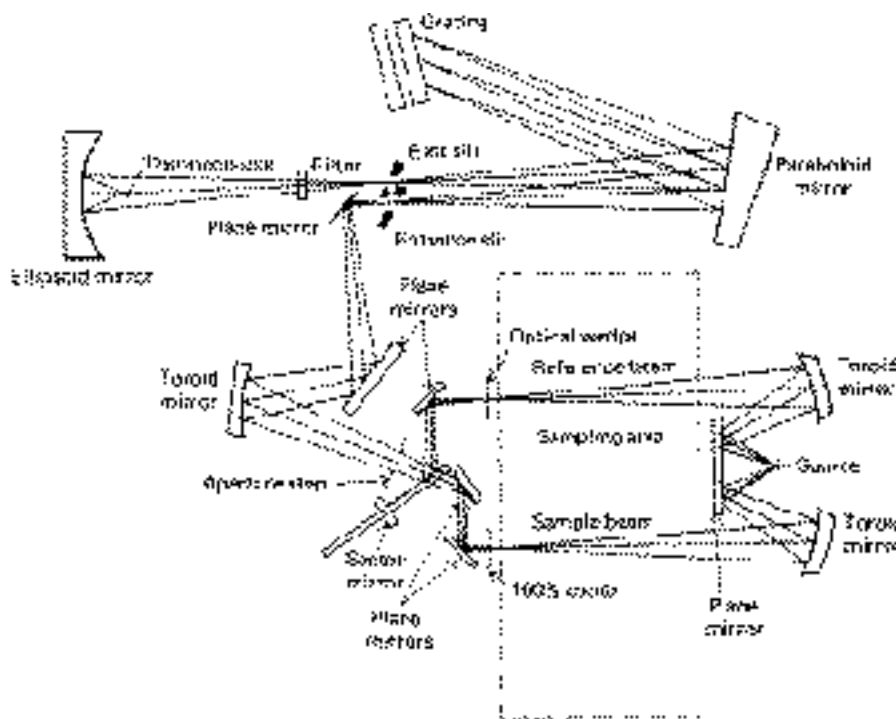

devices (Golay detectors). They measure the heating effect produced by infrared radiation. A variety of physical property changes are quantitatively determined: expansion of a nonabsorbing gas (Golay detector), electrical resistance (thermistor), and voltage at junction of dissimilar metals (thermocouple). Photon detectors rely on the interaction of IR radiation and a semiconductor material. Nonconducting electrons are excited to a conducting state. Thus, a small current or voltage can be generated. Thermal detectors provide a linear response over a wide range of frequencies but exhibit slower response times and lower sensitivities than photon detectors.

Spectrometer Design

In a typical dispersive IR spectrometer, radiation from a broad-band source passes through the sample and is dispersed by a monochromator into component frequencies (Fig. 15.3). Then the beams fall on the detector, which generates an electrical signal and results in a recorder response.

Most dispersive spectrometers have a double-beam design. Two equivalent beams from the same source pass through the sample and reference chambers respectively. Using an optical chopper (such as a sector mirror), the reference and sample beams are alternately focused on the detector. Commonly, the change of IR radiation intensity due to absorption by the sample is detected as an off-null signal that is translated into the recorder response through the actions of synchronous motors.

Fourier Transform Spectrometers

Fourier transform spectrometers have recently replaced dispersive instruments for most applications due to their superior speed and sensitivity. They have greatly extended the capabilities of infrared spectroscopy and have been applied to many areas that are very difficult or nearly impossible to analyze by dispersive instruments. Instead of viewing each component frequency sequentially, as in a dispersive IR spectrometer, all frequencies are examined simultaneously in Fourier transform infrared (FTIR) spectroscopy.

Spectrometer Components

There are three basic spectrometer components in an FT system: radiation source, interferometer, and detector. A simplified optical layout of a typical FTIR spectrometer is illustrated in Fig. 15.4.

The same types of radiation sources are used for both dispersive and Fourier transform spectrometers. However, the source is more often water-cooled in FTIR instruments to provide better power and stability.

In contrast, a completely different approach is taken in an FTIR spectrometer to differentiate and measure the absorption at component frequencies. The monochromator is replaced by an interferometer, which divides radiant beams, generates an optical path difference between the beams, then recombines them in order to produce repetitive interference signals measured as a function of optical path difference by a detector. As its name implies, the interferometer produces interference signals, which contain infrared spectral information generated after passing through a sample.

The most commonly used interferometer is a Michelson interferometer. It consists of three active components: a moving mirror, a fixed mirror, and a beamsplitter (Fig. 15.4). The two mirrors are perpendicular to each other. The beamsplitter is a semireflecting device and is often made by depositing a thin film of germanium onto a flat KBr substrate. Radiation from the broadband IR source is collimated and directed into the interferometer, and impinges on the beamsplitter. At the beamsplitter, half the IR beam is transmitted to the fixed mirror and the remaining half is reflected to the moving mirror. After the divided beams are reflected from the two mirrors, they are recombined at the beamsplitter. Due to

Figure 15.4 Simplified optical layout of a typical FTIR spectrometer. (Reprinted by permission of Nicolet Instrument Corporation.)

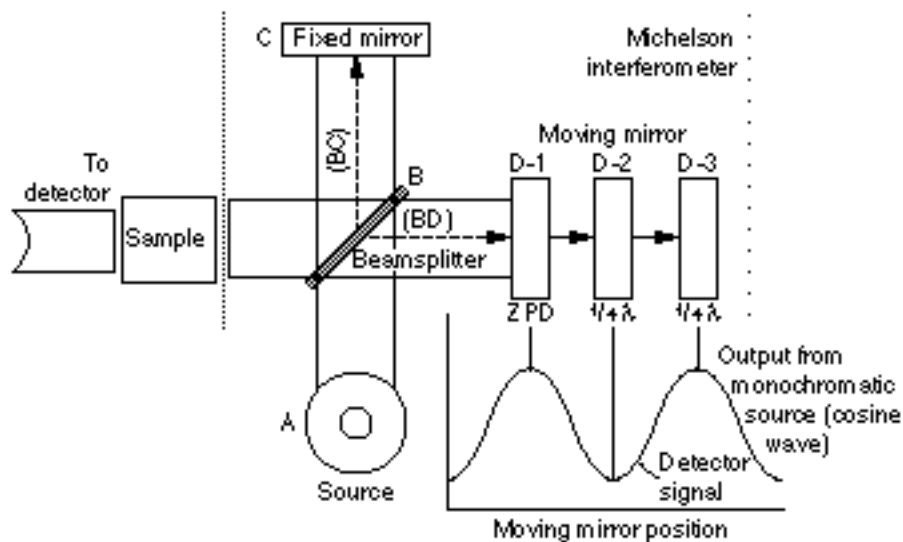

changes in the relative position of the moving mirror to the fixed mirror, an interference pattern is generated. The resulting beam then passes through the sample and is eventually focused on the detector.

For an easier explanation, the detector response for a single-frequency component from the IR source is first considered. This simulates an idealized situation where the source is monochromatic, such as a laser source. As previously described, differences in the optical paths between the two split beams are created by varying the relative position of moving mirror to the fixed mirror. If the two arms of the interferometer are of equal length, the two split beams travel through the exact same path length. The two beams are totally in phase with each other; thus, they interfere constructively and lead to a maximum in the detector response. This position of the moving mirror is called the point of zero path difference (ZPD). When the moving mirror travels in either direction by the distance $\lambda/4$, the optical path (beamsplitter–mirror–beamsplitter) is changed by $2(\lambda/4)$, or $\lambda/2$. The two beams are 180° out of phase with each other, and thus interfere destructively. As the moving mirror travels another $\lambda/4$, the optical path difference is now $2(\lambda/2)$, or λ . The two beams are again in phase with each other and result in another constructive interference.

When the mirror is moved at a constant velocity, the intensity of radiation reaching the detector varies in a sinusoidal manner to produce the interferogram output shown in Fig. 15.4. The interferogram is the record of the interference signal. It is actually a time domain spectrum and records the detector response changes versus time within the mirror scan. If the sample happens to absorb at this frequency, the amplitude of the sinusoidal wave is reduced by an amount proportional to the amount of sample in the beam.

Extension of the same process to three component frequencies results in a more complex interferogram, which is the summation of three individual modulated waves, as shown in Fig. 15.5. In contrast to this simple, symmetric interferogram, the interferogram produced with a broadband IR source displays extensive interference patterns. It is a complex summation of superimposed sinusoidal waves, each wave corresponding to a single frequency. When this IR beam is directed through the sample, the amplitudes of a set of waves are reduced by absorption if the frequency of this set of waves is the same as one of the characteristic frequencies of the sample (Fig. 15.6).

The interferogram contains information over the entire IR region to which the detector is respon-

Figure 15.5 Interferogram consisting of three modulated cosine waves. The greatest amplitude occurs at the point of zero path difference (ZPD). (Reprinted by permission of Nicolet Instrument Corporation.)

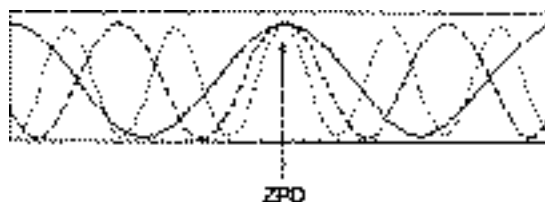

sive. A mathematical operation known as Fourier transformation converts the interferogram (a time domain spectrum displaying intensity versus time within the mirror scan) to the final IR spectrum, which is the familiar frequency domain spectrum showing intensity versus frequency. This also explains how the term *Fourier transform infrared* spectrometry is created.

The detector signal is sampled at small, precise intervals during the mirror scan. The sampling rate is controlled by an internal, independent reference, a modulated monochromatic beam from a helium neon (HeNe) laser focused on a separate detector.

The two most popular detectors for a FTIR spectrometer are deuterated triglycine sulfate (DTGS) and mercury cadmium telluride (MCT). The response times of many detectors (for example, thermocouple and thermistor) used in dispersive IR instruments are too slow for the rapid scan times (1 sec or less) of the interferometer. The DTGS detector is a pyroelectric detector that delivers rapid responses because it measures the changes in temperature rather than the value of temperature. The MCT detector is a photon (or quantum) detector that depends on the quantum nature of radiation and also exhibits very fast responses. Whereas DTGS detectors operate at room temperature, MCT detectors must be maintained at liquid nitrogen temperature (77 °K) to be effective. In general, the MCT detector is faster and

Figure 15.6 A typical interferogram produced with a broadband IR source.

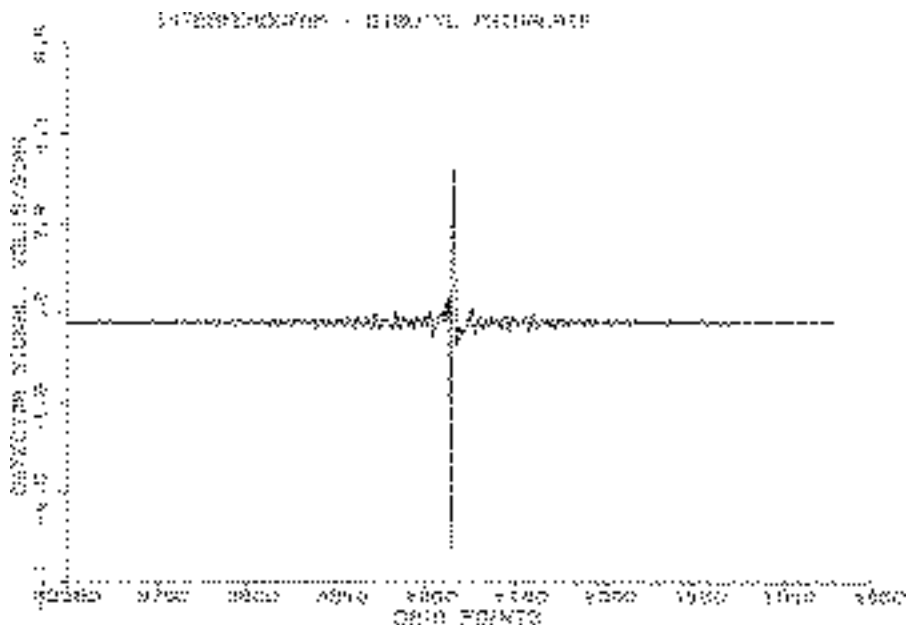

more sensitive than the DTGS detector.

Spectrometer Design

The basic instrument design is quite simple. Figure 15.7 illustrates the design of a typical FTIR spectrometer. The IR radiation from a broadband source is first directed into an interferometer, where it is divided and then recombined after the split beams travel different optical paths to generate constructive and destructive interference. Next, the resulting beam passes through the sample compartment and reaches to the detector.

Most benchtop FTIR spectrometers are single-beam instruments. Unlike double-beam grating spectrometers, single-beam FTIR does not obtain transmittance or absorbance IR spectra in real time. A typical operating procedure is described as follows:

1. A background spectrum (Fig. 15.8) is first obtained by collecting an interferogram (raw data), followed by processing the data by Fourier transform conversion. This is a response curve of the spectrometer and takes account of the combined performance of source, interferometer, and detector. The background spectrum also includes the contribution from any ambient water (two irregular groups of lines at about 3600 cm^{-1} and about 1600 cm^{-1}) and carbon dioxide (doublet at 2360 cm^{-1} and sharp spike at 667 cm^{-1}) present in the optical bench.
2. Next, a single-beam sample spectrum is collected (Fig. 15.9). It contains absorption bands from the sample and the background (air or solvent).

Figure 15.7 Schematic diagram of the Nicolet Magna-IR[®] 750 FTIR Spectrometer. (Reprinted by permission of Nicolet Instrument Corporation.)

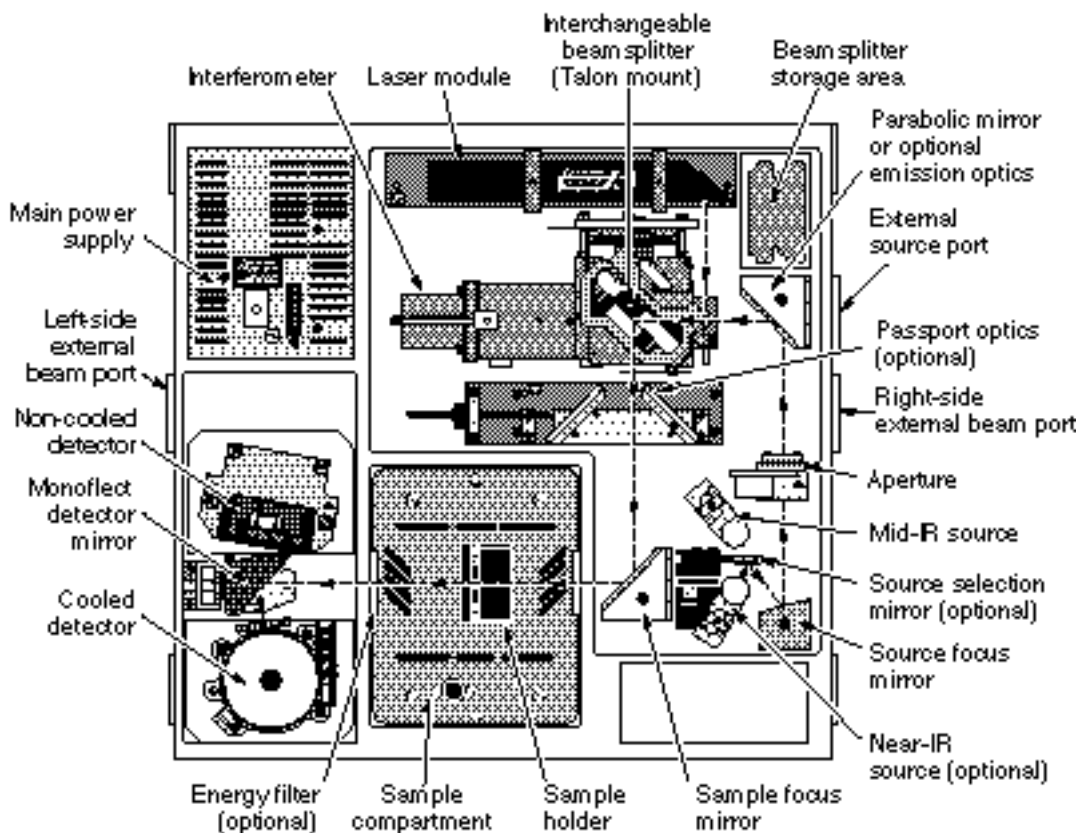
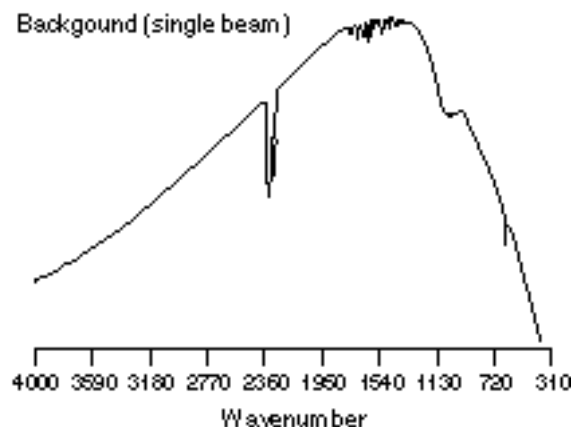

Figure 15.8 A single-beam IR spectrum of background, showing contribution from trace amount of ambient water and carbon dioxide.



3. The ratio of the single-beam sample spectrum in Fig. 15.9 against the single beam background spectrum in Fig. 15.8 results in a “double-beam” spectrum of the sample (Fig. 15.10).

To reduce the strong background absorption from water and carbon dioxide in the atmosphere, the optical bench is usually purged with an inert gas or with dry, carbon dioxide–scrubbed air (from a commercial purge gas generator). Spectrometer alignment, which includes optimization of the beamsplitter angle, is recommended as part of a periodic maintenance or when a sample accessory is changed.

FTIR Advantages

FTIR instruments have distinct advantages over dispersive spectrometers:

- Better speed and sensitivity (Fellgett advantage). A complete spectrum can be obtained during a single scan of the moving mirror, while the detector observes all frequencies simultaneously.

Figure 15.9 A single-beam IR spectrum of dibutyl phthalate (a liquid sample).

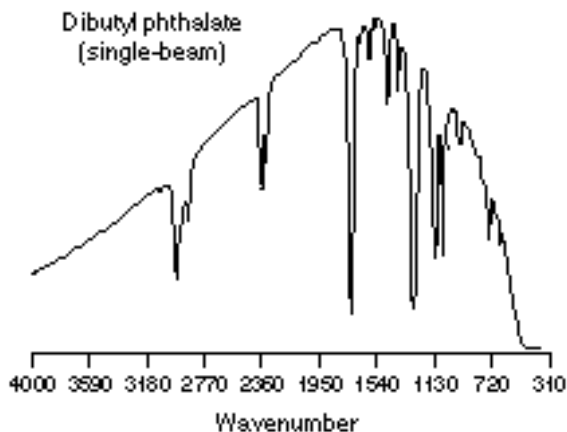
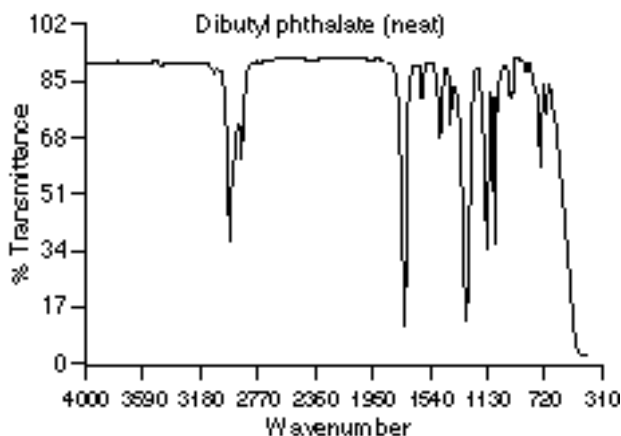

Figure 15.10 The “double-beam” IR spectrum of dibutyl phthalate, produced by ratio of the corresponding single-beam sample spectrum against the single-beam background spectrum.



An FTIR instrument can achieve the same signal-to-noise (S/N) ratio of a dispersive spectrometer in a fraction of the time (1 sec or less versus 10 to 15 min). The S/N ratio is proportional to the square root of the total number of measurements. Because multiple spectra can be readily collected in 1 min or less, sensitivity can be greatly improved by increasing S/N through coaddition of many repeated scans.

- Increased optical throughput (Jacquinot advantage). Energy-wasting slits are not required in the interferometer because dispersion or filtering is not needed. Instead, a circular optical aperture is commonly used in FTIR systems. The beam area of an FT instrument is usually 75 to 100 times larger than the slit width of a dispersive spectrometer. Thus, more radiation energy is made available. This constitutes a major advantage for many samples or sampling techniques that are energy-limited.
- Internal laser reference (Connes advantage). The use of a helium neon laser as the internal reference in many FTIR systems provides an automatic calibration in an accuracy of better than 0.01 cm^{-1} . This eliminates the need for external calibrations.
- Simpler mechanical design. There is only one moving part, the moving mirror, resulting in less wear and better reliability.
- Elimination of stray light and emission contributions. The interferometer in FTIR modulates all the frequencies. The unmodulated stray light and sample emissions (if any) are not detected.
- Powerful data station. Modern FTIR spectrometers are usually equipped with a powerful, computerized data system. It can perform a wide variety of data processing tasks such as Fourier transformation, interactive spectral subtraction, baseline correction, smoothing, integration, and library searching.

Although the spectra of many samples can be satisfactorily run on either FTIR or dispersive instruments, FTIR spectrometers are the preferred choice for samples that are energy-limited or when increased sensitivity is desired. A wide range of sampling accessories is available to take advantage of the capabilities of FTIR instruments.

What It Does

It is possible to obtain an IR spectrum from samples in many different forms, such as liquid, solid, and gas. However, many materials are opaque to IR radiation and must be dissolved or diluted in a transparent matrix in order to obtain spectra. Alternatively, it is possible to obtain reflectance or emission spectra directly from opaque samples. Some popular sampling techniques and accessories are discussed here.

Liquid cells are used for dilute solutions of solid and liquid samples that are dissolved in relatively IR-transparent solvents. Sampling in solution results in enhanced reproducibility and is often the preferred choice. Unfortunately, no single solvent is transparent through the entire mid IR region. The analyst usually chooses solvents that have transparent windows in the region of interest. The conventional popular solvents are carbon tetrachloride for the region between 4000 and 1330 cm^{-1} and carbon disulfide for the region between 1330 and 625 cm^{-1} . Both solvents are quite toxic, and thus must be handled carefully. One may replace carbon tetrachloride with the less-toxic tetrachloroethylene or methylene chloride and substitute carbon disulfide with n-hexane or n-heptane. Polar solvents such as water and alcohols are seldom used because they absorb strongly in the mid IR range and react with alkali-metal halides, such as NaCl, commonly used for cell windows.

Acquiring acceptable IR spectra of aqueous samples requires use of special types of liquid cells such as thin cells of BaF_2 , AgCl, or KRS-5 (a mixed thallium bromide–thallium iodide). Aqueous solution measurements can also be accomplished with attenuated total reflectance (ATR) accessories, which are discussed later in this chapter.

Typically, solutions of 0.05 to 10% in concentration are handled in IR cells of 0.1 to 1 mm in thickness. Concentration of 10% and cell path length of 0.1 mm represent one practical combination. In a double-beam spectrometer, a compensating cell is filled with pure solvent and placed in the reference beam. In the single-beam FT instrument, the solvent bands are mostly removed by obtaining the difference spectra through subtraction of solvent spectra from sample spectra. Both fixed-thickness and variable-thickness liquid cells are available commercially. They normally consist of metal frame plates, IR-transmitting windows, and gaskets that determine the path length of the cells.

Salt plates of IR-transmitting materials can be used for semivolatile and nonvolatile liquid samples. Sodium chloride disks are the most popular and economical choice for nonaqueous liquids. Silver chloride or barium fluoride plates may be used for samples that dissolve or react with NaCl plates. A drop of the neat sample is squeezed between two salt plates to form a film of approximately 0.01 mm in thickness. The plates can be held together by capillary attraction, or they may be clamped in a screw-tightened holder or pressed to form a good contact in a press fit O-ring supported holder. It is also possible to place a film of samples on salt plates by melting a relatively low-melting solid and squeezing it between two plates. Sodium chloride salt plates can usually be cleaned with dry methylene chloride or acetone. This smear technique is one of the simplest ways to obtain IR spectra.

Thin films of nonvolatile liquids or solids can be deposited on an IR-transmitting salt plate by solvent evaporation. The sample is first dissolved in a reasonably volatile solvent. A few drops of the resulting solution are placed on the plate. After evaporating off the solvent, a thin film of sample is obtained for subsequent spectra acquisition.

Disposable IR cards have been developed recently by 3M to accommodate samples that are liquids, are soluble in reasonably volatile solvents, or can be smeared on flat surfaces. The cards are made up of a cardboard holder containing a circular IR-transmitting window made of a microporous substrate (polytetrafluoroethylene substrate for 4000 to 1300 cm^{-1} or polyethylene substrate for 1600 to 400 cm^{-1}). Samples are generally applied to the cards by the techniques used for salt plates. The substrate bands can be subtracted from the sample spectra. Besides the convenience, the disposable IR cards are non-hygroscopic, and thus can handle water-containing samples.

Pellets are used for solid samples that are difficult to melt or dissolve in any suitable IR-transmitting solvents. The sample (0.5 to 1.0 mg) is finely ground and intimately mixed with approximately 100 mg of dry potassium bromide (or other alkali halide) powder. Grinding and mixing can be done with an agate mortar and pestle, a vibrating ball mill (Wig-L-Bug from Crescent Dental Manufacturing), or lyophilization. The mixture is then pressed into a transparent disk in an evacuable die at sufficiently high pressure. Suitable KBr disks or pellets can often be made using a simpler device such as a Mini-Press. To minimize band distortion due to scattering of radiation, the sample should be ground to particles of 2 μm (the low end of the radiation wavelength) or less in size. The IR spectra produced by the pellet technique often exhibit bands at 3450 cm^{-1} and 1640 cm^{-1} due to absorbed moisture.

Mulls are used as alternatives for pellets. The sample (1 to 5 mg) is ground with a mulling agent (1 to 2 drops) to give a two-phase mixture that has a consistency similar to toothpaste. This mull is pressed between two IR-transmitting plates to form a thin film. The common mulling agents include mineral oil or Nujol (a high-boiling hydrocarbon oil), Fluorolube (a chlorofluorocarbon polymer), and hexachlorobutadiene. To obtain a full IR spectrum that is free of mulling agent bands, the use of multiple mulls (such as Nujol and Fluorolube) is generally required. Thorough mixing and reduction of sample particles of 2 μm or less in size are very important in obtaining a satisfactory spectrum.

Gas cells can be used to examine gases or low-boiling liquids. These cells consist of a glass or metal body, two IR-transparent end windows, and valves for filling gas from external sources. They provide vacuum-tight light paths from a few centimeters to 120 m. Longer path lengths are obtained by reflecting the IR beam repeatedly through the sample using internal mirrors located at the ends of the cell. Sample gas pressure required to produce reasonable spectra depends on the sample absorbance and the cell's path length. Typically, a good spectrum can be acquired at a partial pressure of 50 torr in a 10-cm cell. Analysis of multicomponent gas samples at parts-per-billion levels can be successfully performed.

Microsampling accessories such as microcells, microcavity cells, and micropellet dies are used to examine microquantities of liquids (down to 0.5 μL) and solids (down to 10 μg). Beam-condensing devices are often used to reduce the beam size at the sampling point. Extra practice is recommended for performing this type of microanalysis.

Attenuated total reflectance (ATR) accessories are especially useful for obtaining IR spectra of difficult samples that cannot be readily examined by the normal transmission method. They are suitable for studying thick or highly absorbing solid and liquid materials, including films, coatings, powders, threads, adhesives, polymers, and aqueous samples. ATR requires little or no sample preparation for most samples and is one of the most versatile sampling techniques.

ATR occurs when a beam of radiation enters from a more-dense (with a higher refractive index) into a less-dense medium (with a lower refractive index). The fraction of the incident beam reflected increases when the angle of incidence increases. All incident radiation is completely reflected at the interface when the angle of incidence is greater than the critical angle (a function of refractive index). The beam penetrates a very short distance beyond the interface and into the less-dense medium before the complete reflection occurs. This penetration is called the evanescent wave and typically is at a depth of a few micrometers (μm). Its intensity is reduced (attenuated) by the sample in regions of the IR spectrum where the sample absorbs. Figure 15.11 illustrates the basic ATR principles.

The sample is normally placed in close contact with a more-dense, high-refractive-index crystal such as zinc selenide, thallium bromide–thallium iodide (KRS-5), or germanium. The IR beam is directed onto the beveled edge of the ATR crystal and internally reflected through the crystal with a single or multiple reflections. Both the number of reflections and the penetration depth decrease with increasing angle of incidence. For a given angle, the higher length-to-thickness ratio of the ATR crystal gives higher numbers of reflections. A variety of types of ATR accessories are available, such as 25 to 75° vertical variable-angle ATR, horizontal ATR, and Spectra-Tech Cylindrical Internal Reflectance Cell

for Liquid Evaluation (CIRCLE[®]) cell.

The resulting ATR-IR spectrum resembles the conventional IR spectrum, but with some differences: The absorption band positions are identical in the two spectra, but the relative intensities of corresponding bands are different. Although ATR spectra can be obtained using either dispersive or FT instruments, FTIR spectrometers permit higher-quality spectra to be obtained in this energy-limited situation.

Specular reflectance provides a nondestructive method for measuring thin coatings on selective, smooth substrates without sample preparation. It basically involves a mirrorlike reflection and produces reflection measurements for a reflective material, or a reflection-absorption spectrum for the surface film on a reflective surface. Thin surface coatings in the range from nanometers to micrometers can be routinely examined with a grazing angle (typically 70 to 85°) or 30° angle of incidence, respectively. For example, lubricant thickness on magnetic media or computer disks is conveniently measured using this technique.

Diffuse reflectance technique is mainly used for acquiring IR spectra of powders and rough surface solids such as coal, paper, and cloth. It can be used as an alternative to pressed-pellet or mull techniques. IR radiation is focused onto the surface of a solid sample in a cup and results in two types of reflections: specular reflectance, which directly reflects off the surface and has equal angles of incidence and reflectance, and diffuse reflectance, which penetrates into the sample, then scatters in all directions. Special reflection accessories are designed to collect and refocus the resulting diffusely scattered light by large ellipsoidal mirrors, while minimizing or eliminating the specular reflectance, which complicates and distorts the IR spectra. This energy-limited technique was not popular until the advent of FTIR instruments. This technique is often called diffuse reflectance infrared Fourier transform spectroscopy (DRIFTS).

The sample can be analyzed either directly in bulk form or as dispersions in IR-transparent matrices such as KBr and KCl. Dilution of analyte in a nonabsorbing matrix increases the proportion of diffuse reflectance in all the light reflected. Typically the solid sample is diluted homogeneously to 5 to 10% by weight in KBr. The spectra of diluted samples are similar to those obtained from pellets when plotted in units such as $\log 1/R$ (R is the reflectance) or Kubelka-Munk units. The Kubelka-Munk format relates sample concentration to diffuse reflectance and applies a scattering factor.

Photoacoustic spectroscopy (PAS) is a useful extension of IR spectroscopy and suitable for examining highly absorbing samples that are difficult to analyze by conventional IR techniques. The size and shape of the sample are not critical. PAS spectra can be obtained with minimal sample preparation and without physical alteration from a wide variety of samples such as powders, polymer pellets, viscous glues, single crystals, and single fibers.

Typically, the modulated IR radiation from an FTIR interferometer is focused on a sample placed

Figure 15.11 Schematic representation of multiple internal reflection effect in Attenuated Total Reflectance (ATR). (Reprinted from 1988 Annual Book of ASTM Standards by permission of American Society for Testing and Materials.)

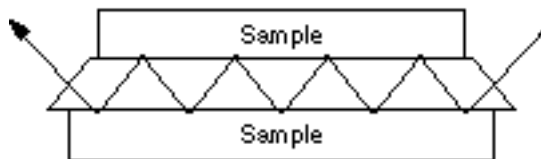

in a small cup inside a small chamber containing an IR-transparent gas such as helium or nitrogen. IR radiation absorbed by the sample converts into heat inside the sample. The heat diffuses to the sample surface, then into the surrounding gas atmosphere, and causes expansion of a boundary layer of gas next to the sample surface. Thus, the modulated IR radiation produces intermittent thermal expansion of the boundary layer and generates pressure waves. A sensitive microphone is used to detect the resulting photoacoustic signal.

PAS spectra are generally similar to conventional IR spectra except for some minor differences: Absorbance peaks appear at the same frequency locations, but truncation of strong absorbance bands due to photoacoustic signal saturation is often observed. However, the presence of such truncated bands does not limit the practical use of PAS. Spectral search against standard commercial spectral libraries can be satisfactorily performed. FTIR PAS technique also offers a unique capability for examining samples at various depths from 1 to 20 μm . The acoustic frequencies depend on the modulated frequency of source: The slower the modulation frequency, the greater depth of penetration. Thus, samples such as multilayer polymers can be studied at various depths by simply varying the scan speed of the FTIR spectrometer.

Emission spectroscopy is another technique used with difficult samples such as thin coatings and opaque materials. The sample is normally heated to an elevated temperature, emitting enough energy to be detected. The sample acts as the radiation source, so the normal IR source is turned off. The ability of FTIR instruments to obtain spectra from weak signals makes it possible to study emission in the infrared region, even when the sample is at low temperatures such as 50 to 100 $^{\circ}\text{C}$. Emission spectral bands occur at the same frequencies as absorption bands. The spectra from thick samples can be complicated when radiation from the interior of the sample is self-absorbed by the outer part of the sample.

Infrared microspectroscopy has become a popular technique for analyzing difficult or small samples such as trace contaminants in semiconductor processing, multilayer laminates, surface defects, and forensic samples. Infrared microscopes are energy-inefficient accessories that require the signal-to-noise advantages of FTIR to obtain spectra from submilligram samples. Using a liquid nitrogen cooled mercury cadmium telluride (MCT) detector, samples in the size range of 10 μm can be examined on IR microscopes.

The primary advantages of the IR microscope relate not only to its improved optical and mechanical design, but also to its manipulative capability. In many cases, the major problem in microsampling is focusing the spectrometer beam on the sample. The computerized/motorized control of microscope functions of IR microscope instruments permit these extremely small samples to be moved in the field of view to isolate the portion from which spectra are obtained.

Fiberoptic accessories deliver unique flexibility and diversity in sampling. They are particularly useful in acquiring IR spectra when samples are situated in a remote location or when the unusual size or shape of samples prevents them from fitting well in a standard sample compartment. Many analyses in hazardous or process environments used these devices.

Fiberoptic sample probes or flow cells are coupled to standard FTIR spectrometers with two fiberoptic cables and an optic interface that transfers IR radiation from spectrometer to fiberoptic cables. A variety of probes are available for ATR, specular reflectance, diffuse reflectance, and transmittance measurements. Chalcogenide (GeAsSeTe), a mid IR-transmitting material in the range of 4000 to 900 cm^{-1} , was recently developed by Spectra-Tech and used to make the fiberoptic cables.

Hyphenated Methods Involving Infrared

Gas chromatography/Fourier transform infrared (GC/FTIR) spectroscopy is a technique that uses a gas chromatograph to separate the components of sample mixtures and an FTIR spectrometer to provide identification or structural information on these components. The real potential of GC-IR instrumenta-

tion was not widely used until the fast-scanning, sensitive FTIR spectrometers became available commercially.

The most commonly used GC/FTIR interface is a light pipe flow cell. The light pipe is typically a piece of glass tubing 10 to 20 cm long, approximately 1 mm inside diameter, gold coated on the inside, with IR-transmitting windows on each end. This design provides a long path length and low dead volume (90 to 300 μL), resulting in high IR absorbance with minimal peak broadening. The light pipe is connected to the effluent port of the gas chromatograph by a heated transfer line. The gas flow assembly can be heated up to 350 $^{\circ}\text{C}$ to prevent sample components from condensing onto the light pipe and transfer line. Figure 15.12 illustrates the optical design of a GC/FTIR interface.

Eluents from a capillary gas chromatograph flow through the transfer line into the light pipe, where the IR spectra are acquired in real time with a rate up to 20 spectra per second. The light-pipe GC/FTIR offers nanogram-level sensitivity. Typically, a usable spectrum can be obtained from 5 to 20 ng of component compound. The flow emerging from the chromatograph is often split between the light pipe and a conventional GC detector (flame ionization, thermal conductivity, or mass spectrometer). This permits the simultaneous generation of a normal chromatogram and the corresponding IR spectra for each chromatographic peak. Alternatively, the total flow after the light pipe can be routed into a conventional detector to provide in-line detection by a flame ionization or mass spectrometer detector. In fact, the combination of a gas chromatograph with an FTIR and mass spectrometer (GC/FTIR/MS) is available commercially.

Although common GC/FTIR spectroscopy is not as sensitive as gas chromatography/mass spectrometry (GC/MS), GC/FTIR offers a major advantage over GC/MS: the ability to identify structural isomers. In addition, the sensitivity of GC/FTIR can be further improved by matrix isolation or direct deposition techniques.

Gas chromatography/matrix isolation/Fourier transform infrared (GC/MI/FTIR) spectroscopy provides subnanogram sensitivity, but is a very expensive technique. The helium carrier gas of a gas chromatograph is mixed with a small amount of argon. While argon is condensed in a track of 300 μm width

Figure 15.12 Schematic diagram of a GC/FTIR interface.
(Reprinted by permission of Nicolet Instrument Corporation.)

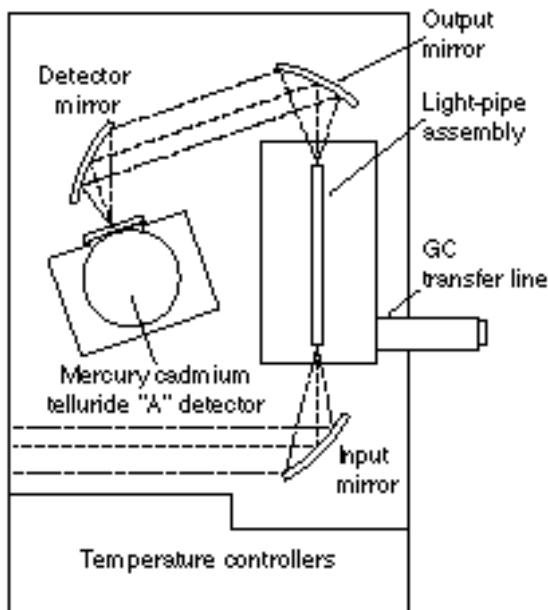

on a rotating circular gold-coated metal disk cooled at 12 °K, the helium gas is evacuated by pumping. The components separated by the chromatograph are dissolved and trapped in the argon matrix. After the GC run is completed, the argon track is rotated into the IR beam and the reflection-absorption IR spectra are obtained for each component on the cooled surface. Cryogenic temperatures are maintained while the spectra are acquired.

In GC/MI/FTIR, the components are isolated in small areas. Because IR measurements are not made in real time, these components can be held in the IR beam for longer periods, allowing improved signal-to-noise ratios through averaging of multiple scans. Thus, GC/MI/FTIR offers significant sensitivity improvement over light-pipe GC/FTIR.

Gas chromatography/direct deposition/Fourier transform infrared (GC/DD/FTIR) spectroscopy is another sensitive technique that permits a usable spectrum to be obtained with 100 pg of component compound. The separated components are directly deposited in a track of 100 μm width on a liquid-nitrogen-cooled, IR-transmitting disk such as zinc selenide. Transmission IR spectra can be taken in real time. Alternatively, the isolated components can be repositioned in the IR beam after the run is completed to gain the multiscan signal-averaging advantages.

High-performance liquid chromatography/Fourier transform infrared (HPLC/FTIR) spectroscopy uses the same approach as the GC/DD/FTIR to eliminate the mobile phase and gain satisfactory sensitivity.

Conventional flow cells for HPLC chromatograph generally do not provide adequate sensitivity, due to the IR absorption of all HPLC mobile phases. Instead, an HPLC/FTIR interface using the direct deposition technique has been designed and delivers subnanogram sensitivity (1). The interface consists of two concentric fused silica tubes of different internal diameters. While the eluate stream from an HPLC column flows through the inner tube, a sheath of heated gas (helium or air) passes through the outer tube. The nebulized spray is directed to a rotating sample collection disk onto which the component compounds are deposited. During the process the mobile phase is evaporated. The resulting depositions of sample components can then be positioned in the IR beam and their IR spectra collected.

Other techniques involving IR spectrometers, including supercritical fluid chromatography/Fourier transform infrared (SFC/FTIR) spectroscopy, thermogravimetry/Fourier transform infrared (TGA/FTIR) spectroscopy and, gas chromatography/Fourier transform infrared/mass spectrometry (GC/FTIR/MS) have also become available commercially. They generally use more cost-effective flow-through interfaces.

Analytical Information

Qualitative

The combination of the fundamental vibrations or rotations of various functional groups and the subtle interactions of these functional groups with other atoms of the molecule results in the unique, generally complex IR spectrum for each individual compound. IR spectroscopy is mainly used in two ways: structural elucidation and compound identification.

Structural Elucidation

Because of complex interactions of atoms within the molecule, IR absorption of the functional groups may vary over a wide range. However, it has been found that many functional groups give characteristic

IR absorption at specific, narrow frequency ranges regardless of their relationship with the overall IR molecule. Generalized tables of the positions and relative intensities of absorption bands (Fig. 15.14) have been established and used to determine the functional groups present or absent in a molecule. The *CRC Handbook of Chemistry and Physics* (2), Silverstein, Bassler, and Morrill's book (3), and a number of other publications all contain useful correlation charts.

Multiple functional groups may absorb at one particular frequency range, but a functional group often gives rise to multiple-characteristic absorption. Thus, the spectral interpretations should not be confined to one or two bands and the whole spectrum should be examined. To confirm or better elucidate the structure of an unknown substance, other analytical information provided by nuclear magnetic resonance (NMR), mass spectrometry (MS), or other chemical analysis should also be used where possible. For systematic evaluation, the IR spectrum is commonly divided into three regions.

The Functional Group Region, 4000 to 1300 cm^{-1} The appearance of strong absorption bands in the region of 4000 to 2500 cm^{-1} usually comes from stretching vibrations between hydrogen and some other atoms with a mass of 19 or less. The O-H and N-H stretching frequencies fall in the 3700 to 2500 cm^{-1} region, with various intensities. Hydrogen bonding has a significant influence on the peak shape and intensity, generally causing peak broadening and shifts in absorption to lower frequencies. The C-H stretching bands occur in the region of 3300 to 2800 cm^{-1} . The acetylenic C-H exhibits strong absorption at about 3300 cm^{-1} . Alkene and aromatic C-H stretch vibrations absorb at 3100 to 3000 cm^{-1} . Most aliphatic (saturated) C-H stretching bands occur at 3000 to 2850 cm^{-1} , with generally prominent intensities that are proportional to the number of C-H bonds. Aldehydes often show two sharp aldehydic C-H stretching absorption bands at 2900 to 2700 cm^{-1} .

The absorption bands at the 2700 to 1850 cm^{-1} region usually come only from triple bonds and other limited types of functional groups, such as C \equiv C at 2260 to 2100 cm^{-1} , C \equiv N at 2260 to 2220 cm^{-1} , diazonium salts $-\text{N}^+ \equiv \text{N}$ at approximately 2260 cm^{-1} , allenes C=C=C at 2000 to 1900 cm^{-1} , S-H at 2600 to 2550 cm^{-1} , P-H at 2440 to 2275 cm^{-1} , Si-H at 2250 to 2100 cm^{-1} .

The 1950 to 1450 cm^{-1} region exhibits IR absorption from a wide variety of double-bonded functional groups. Almost all the carbonyl C=O stretching bands are strong and occur at 1870 to 1550 cm^{-1} . Acid chlorides and acid anhydrides give rise to IR bands at 1850 to 1750 cm^{-1} . Whereas ketones, aldehydes, carboxylic acids, amides, and esters generally show IR absorption at 1750 to 1650 cm^{-1} , carboxylate ions usually display stretching bands at 1610 to 1550 and 1420 to 1300 cm^{-1} . Conjugation, ring size, hydrogen bonding, and steric and electronic effects often result in significant shifts in absorption frequencies. Nonconjugated aliphatic C=C and C=N have absorption bands at 1690 to 1620 cm^{-1} , with variable intensities. Aromatic compounds contain delocalized π electrons from the resonance-stabilized double bonds, showing skeletal vibrations (including C-C stretchings within the ring) in the 1650 to 1400 cm^{-1} region and weak combination and overtone bands in the 2000 to 1650 cm^{-1} region. Valuable information about the substitution pattern on an aromatic ring can be obtained by careful examination of absorption bands in these two regions. Molecules containing NO_2 groups, such as nitro compounds, nitrates, and nitramines, commonly exhibit asymmetric and symmetric stretching vibrations of the NO_2 group at 1660 to 1500 and 1390 to 1260 cm^{-1} regions.

The Fingerprint Region, 1300 to 910 cm^{-1} Absorptions in this region include the contributions from complex interacting vibrations, giving rise to the generally unique fingerprint for each compound. A good match between the IR spectra of two compounds in all frequency ranges, particularly in the fingerprint region, strongly indicates that they have the same molecular structures.

Detailed interpretation of IR bands in this region is difficult. However, some assignments of bands in the fingerprint region to a few important vibrational frequencies of functional groups can be done when IR absorptions in other regions are correlated together. For example, esters not only show their

Figure 15.13 Infrared correlation chart of major functional groups. (Reprinted with permission from D. R. Lide, Handbook of Chemistry and Physics, 75th edition, Boca Raton, FL: CRC Press. Copyright © 1994 CRC Press, Boca Raton, Florida.)



Figure 15.13 (continued)



Figure 15.13 (continued)

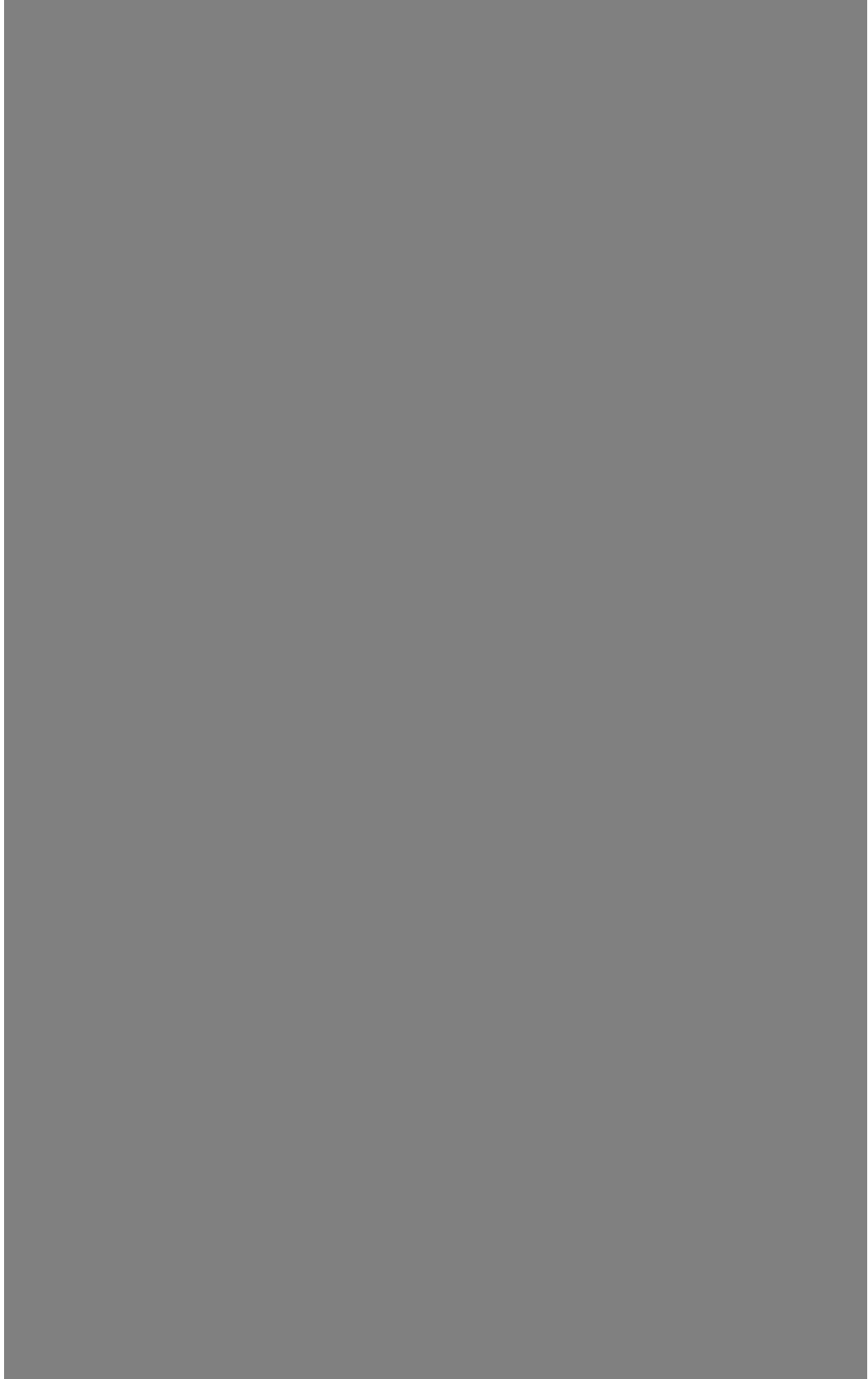

carbonyl C=O stretch at 1750 to 1735 cm^{-1} , but also exhibit their characteristic absorption at 1300 to 1000 cm^{-1} from the couplings of C-O and C-C stretches.

The Aromatic Region, 910 to 650 cm^{-1} The IR bands in this region do not necessarily come from the aromatic compounds, but the absence of strong absorption in the 910 to 650 cm^{-1} region usually indicates the lack of aromatic characters. The out-of-plane bending of ring C-H bonds of aromatic and heteroaromatic compounds gives rise to strong IR bands in the range between 910 and 650 cm^{-1} . As previously stated, certain nonaromatic molecules such as amines and amides can also contribute absorption in this region.

Compound Identification

Since the IR spectrum of every molecule is unique, one of the most positive identification methods of an organic compound is to find a reference IR spectrum that matches that of the unknown compound.

A large number of reference spectra for vapor and condensed phases are available in printed and electronic formats. The spectral libraries compiled by Sadtler and Aldrich are some of the most popular collections. In addition, spectral databases are often compiled according to application areas such as forensics, biochemicals, and polymers. Computerized search programs can facilitate the matching process. In many cases where exact match to the spectrum of an unknown material cannot be found, these programs usually list the reference compounds that match the unknown spectrum most closely. This information is useful in narrowing the search. When it is combined with the data from other analysis such as NMR or mass spectrometry, a positive identification or high-confidence level tentative identification can often be achieved.

Quantitative

IR spectroscopy was generally considered to be able to provide only qualitative and semiquantitative analyses of common samples, especially when the data were acquired using the conventional dispersive instruments. However, the development of reliable FTIR instrumentation and strong computerized data-processing capabilities have greatly improved the performance of quantitative IR work. Thus, modern infrared spectroscopy has gained acceptance as a reliable tool for quantitative analysis.

The basis for quantitative analysis of absorption spectrometry is the Bouguer–Beer–Lambert law, commonly called Beer's law. For a single compound in a homogeneous medium, the absorbance at any frequency is expressed as

$$A = abc \quad (15.3)$$

where A is the measured sample absorbance at the given frequency, a is the molecular absorptivity at the frequency, b is the path length of source beam in the sample, and c is the concentration of the sample. This law basically states that the intensities of absorption bands are linearly proportional to the concentration of each component in a homogeneous mixture or solution.

Deviations from Beer's law occur more often in infrared spectroscopy than in UV/visible spectroscopy. These deviations stem from both instrumental and sample effects. Instrumental effects include insufficient resolution and stray radiation. Resolution is closely related to the slit width in dispersive IR instruments or the optical path difference between two beams in the interferometer of FTIR spectrometers. Stray light levels in FT instruments are usually negligible. Sample effects include chemical reactions and molecular interactions such as hydrogen bonding. The Beer's law deviations result in a nonlinear relationship for plots of absorbance (A) against concentration (c). It is therefore a good practice to obtain calibration curves that are determined empirically from known standards.

Instead of the transmittance scale, absorbance is generally used in quantitative analysis. Absorbance (A) is defined as the negative logarithm of the transmittance (T). According to Beer's law, a linear relationship exists only between the sample concentration and absorbance, not between the sample concentration and transmittance. The linearity of Beer's law plots usually holds better when the absorbance is limited to less than 0.7 absorbance units, although in some cases good linearity has been achieved over more than 2 absorbance units. A number of quantification parameters, which include peak height, peak area, and derivatives, can be used in quantitative analysis. The integration limits for peak area determinations should be carefully chosen to ensure maximum accuracy.

In multicomponent quantitative analysis, the determination of the composition of mixtures involves the use of software packages. These analyses usually assume that Beer's law is additive for a mixture of compounds at a specified frequency. For a simple two-component mixture, the total absorbance, A_T , of the mixture at a given frequency is the sum of the absorbance of two component compounds, x and y , at the specified frequency:

$$A_T = A_x + A_y = a_x b c_x + a_y b c_y \quad (15.4)$$

It is necessary to determine a_x and a_y from absorption measurements of mixtures containing known amounts of compounds x and y at two different frequencies, n and m . Using these values, $a_{x,n}$, $a_{x,m}$, $a_{y,n}$, and $a_{y,m}$, it is possible to use two absorbance measurements from the mixture of unknown composition to determine the concentrations of compounds x and y , c_x and c_y .

$$A_{T,n} = A_{x,n} + A_{y,n} = a_{x,n} b c_x + a_{y,n} b c_y \quad (15.5)$$

$$A_{T,m} = A_{x,m} + A_{y,m} = a_{x,m} b c_x + a_{y,m} b c_y \quad (15.6)$$

Using matrix algebra it is possible to extend this technique to mixtures containing more than two components. The absorbance of a mixture of n independently absorbing components at a particular frequency may be expressed in the following equation:

$$A = a_1 b c_1 + a_2 b c_2 + \dots + a_n b c_n \quad (15.7)$$

where A = total absorbance of the sample at the frequency, a_j = absorptivity of component j at the frequency ($j = 1, 2, \dots, n$), c_j = concentration of component j , and b = sample path length.

Software packages containing matrix methods available with computerized spectrometers simplify the operations associated with multicomponent analysis. If deviations of Beer's law occur, but the law of additivity still holds, sophisticated correlation or statistical evaluation software programs such as least-squares regression, partial least-squares regression, and principal component regression analysis facilitate satisfactory curve-fitting and data-processing tasks.

The broad absorption bands, larger values of absorptivity and sample path length, higher-intensity sources, and more sensitive detectors make the ultraviolet, visible, and near IR regions better suited for quantitative determinations than the mid IR and far IR regions. However, coupling of the advancement of computerized FTIR instrumentation and meticulous attention to detail can make FTIR a viable option for reliable quantitative analysis.

Applications

1. Analysis of Petroleum Hydrocarbons, Oil, and Grease Contents

by EPA Methods.

The Environmental Protection Agency (EPA) has established Methods 413.2 and 418.1 for the measurement of fluorocarbon-113 extractable matter from surface and saline waters and industrial and domestic wastes (4). These methods provide semiquantitative determination of petroleum hydrocarbons, oil, and grease by comparison of the infrared absorption of the sample extract with standards.

Petroleum hydrocarbons, oil, and grease include biodegradable animal greases and vegetable oils along with the relative nonbiodegradable mineral oils. They all contain carbon-hydrogen bonds, thus giving rise to C-H stretching absorption in the 3100 to 2700 cm^{-1} region of the IR spectrum. Fluorocarbon-113 (1,1,2-trichloro-1,2,2-trifluoroethane) is one of the chlorofluorocarbons commonly called freons. It contains no C-H bonds, and thus does not absorb IR radiation in the aforementioned 3100 to 2700 cm^{-1} region. The quantity of hydrocarbons, oil, and grease in freon extracts can be estimated by measuring the intensity of C-H absorption band at 2930 cm^{-1} .

The sample is acidified to a low pH (less than 2) and extracted with fluorocarbon-113. Interference is usually removed with silica adsorbent. Depending on the sample concentration, a cell of path length from 10 to 100 mm can be used to acquire the normal transmission IR spectrum. The concentration of hydrocarbon, oil, and grease in the extract is determined by comparing the absorbance against the calibration plot prepared from standard calibration mixtures. Figure 15.14 shows the different FTIR profiles of three calibration standards. The contributions from the solvent and cell are eliminated by subtracting the reference spectrum of freon from the sample spectrum.

In the standard EPA methods, peak height at a single frequency, 2930 cm^{-1} , is used as the basis for quantification. In the author's laboratory, peak area integration from 3150 to 2700 cm^{-1} is used to quantify the contents of hydrocarbons, oil, and grease. The modified methods have been found to provide significantly improved results in quantitative analysis. Aromatic hydrocarbons have relatively lower absorption intensity in this C-H stretching region, thus giving lower response factors when compared to the IR absorption of oil and grease standards. Using an FTIR instrument, oil and grease at low parts-per-million levels can be readily determined.

2. Quantitative Analysis of Multicomponent Mixtures of Sulfur Oxygen Anions by Attenuated Total Reflectance Spectroscopy.

Characterization of complex mixtures of sulfur oxygen anions is encountered in studies such as investigating the decomposition of the dithionite anion in acidic aqueous solution. Many techniques such as conventional IR, UV/visible, Raman spectroscopy, and titrimetric and electrochemical analysis all have drawbacks that limit their effectiveness in this challenging analysis. The multicomponent analysis by FTIR attenuated total reflectance (ATR) spectroscopy successfully provides the accurate quantification of multiple sulfur-oxygen anion concentrations in aqueous solution (5).

Sulfur-oxygen compounds have relatively intense S-O stretching absorption bands in the 1350 to 750 cm^{-1} region of the IR spectrum. FTIR/ATR spectroscopy is well suited for quantitative determination of sulfur oxygen anions in strong IR-absorbing aqueous medium. ATR not only uses water-resistant cell material, but also has a very short and reproducible effective path length that goes beyond the sample/crystal interface and into the sample medium. A micro CIRCLE cell from Spectra-Tech incorporating a ZnSe crystal is used in the study. Its basic optics is illustrated in Fig. 15.15. The representative FTIR/ATR spectra of sulfur oxide and nitrate anions are shown in Fig. 15.16.

Aqueous decomposition of sodium dithionite under anaerobic conditions is investigated. Systematic baseline error is characterized and taken into account. Computerized data processing involving least-squares regression is used in the multivariate analysis. Figure 15.17 illustrates the simultaneous measurements of concentrations of seven anions and continuous monitoring of total sulfur and average

Figure 15.14 FTIR spectra of three calibration standards, at 1.5, 3.1, and 6.2 ppm, for oil and grease analysis.

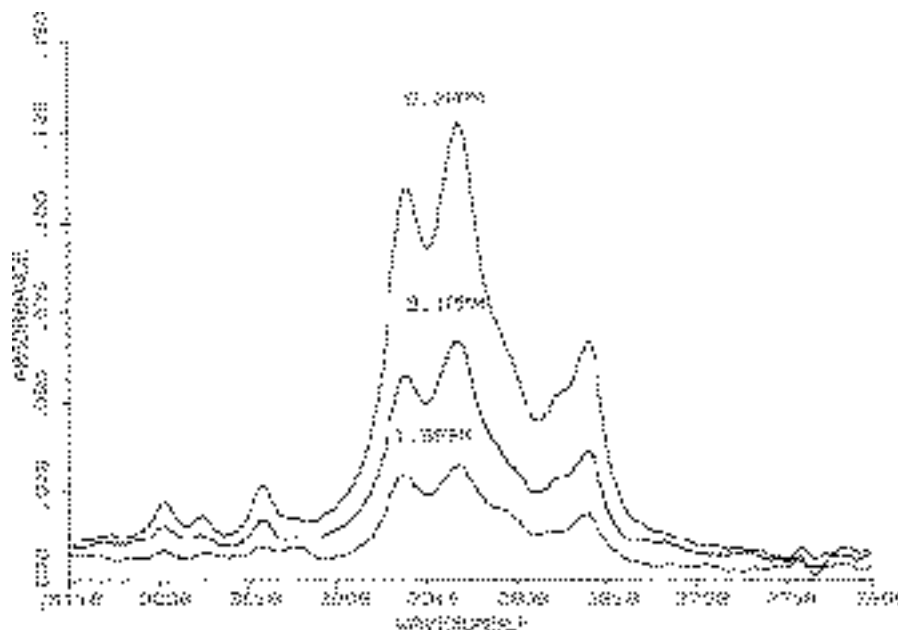

oxidation states over a 30-min reaction period. This analytical technique successfully determines the reaction orders and reaction stoichiometry shown below:

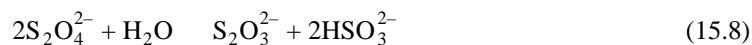

3. Characterization of Heterogeneous Catalysts by Diffuse Reflectance Spectroscopy.

Vibrational spectroscopy has been long established as one of the preferred techniques in obtaining important information on the nature of molecules that are attached to the catalyst surfaces. Diffuse reflectance (DR) spectroscopy has been shown to provide additional advantages over the conventional transmission methods. Detailed characterization of an olefin polymerization catalyst is described here to demonstrate one of the practical applications (6).

Heterogeneous catalysts often consist of active molecules in a distribution of valence states supported on high-surface-area oxides, such as silica and alumina. To better understand Ziegler–Natta catalysts (important catalysts for olefin polymerization processes), the reactions of attaching titanium chloride (TiCl_4) to modified silica surfaces are studied. A diffuse reflectance accessory from Harrick Scientific (Fig. 15.18) and a controlled-atmosphere, high-temperature cell are used in the experiments.

Catalyst samples are diluted by making a 10% w/w dispersion in dry KCl powder. Diffuse reflectance spectra of 200 °C pretreated silica gel before and after reaction with hexamethyldisilazane (HMDS) and 600 °C pretreated silica gels are shown in Fig. 15.19. The chemical reactions on modified silica gel surfaces are illustrated in Fig. 15.20. The 200 °C pretreated silica gel exhibits three surface hydroxyl absorption bands at 3740, 3660, and 3540 cm^{-1} , which arise from relatively free, non-hydrogen-bonded, and hydrogen-bonded silanols (Si-OH), respectively. After surface modification with

Figure 15.15 Optic diagram of the Cylindrical Internal Reflectance Cell for Liquid Evaluation (CIRCLE). (Reprinted by permission of Spectra-Tech, Inc.)

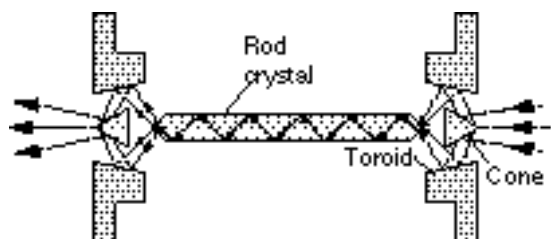

HMDS treatment, the 3740 cm^{-1} peak disappears while the broader bands from hydrogen-bonded silanols remain relatively unperturbed. Baking of the silica gel to $600\text{ }^{\circ}\text{C}$ results in the disappearance of peaks at 3660 and 3540 cm^{-1} , but does not significantly affect the non-hydrogen-bonded silanols' absorption at 3740 cm^{-1} . Diffuse reflectance spectra of $200\text{ }^{\circ}\text{C}$ pretreated silica gel before and after TiCl_4 reaction, along with the spectrum resulting from spectral subtraction are shown in Fig. 15.21 (7). The IR absorption bands at 990 and 920 cm^{-1} in the difference spectrum are assigned to the Si-O stretchings of Si-O-TiCl_3 and $(\text{Si-O})_2\text{-TiCl}_2$, respectively. Similar analyses support the other reactions illustrated in Fig. 15.20.

Figure 15.16 Representation of FTIR/ATR spectra of nitrate and four sulfur oxide anions. (Reprinted with permission from D. A. Holman, A. W. Thompson, D. W. Bennett and J. D. Otvos, *Analytical Chemistry*, Vol. 66, No. 9, 1378–1384. Copyright 1994 American Chemical Society.)

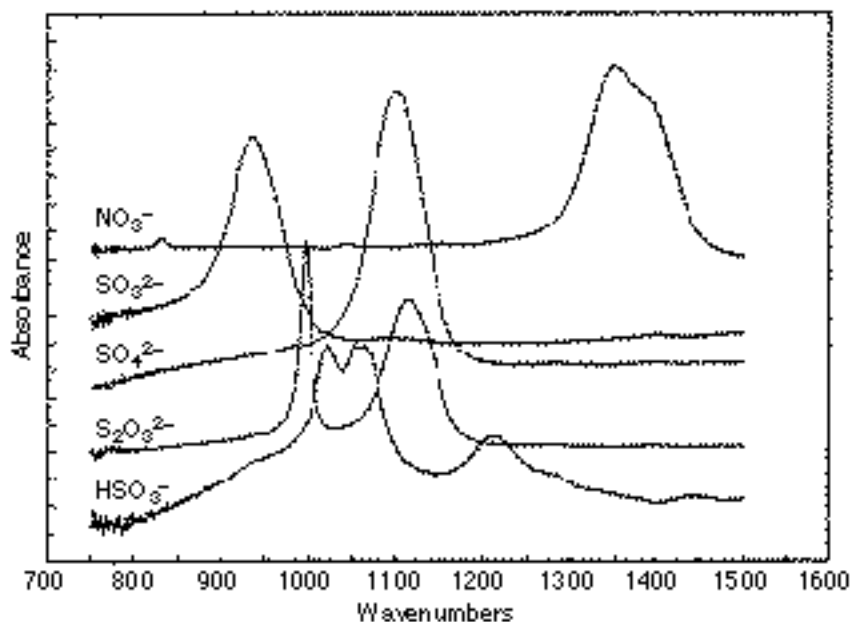
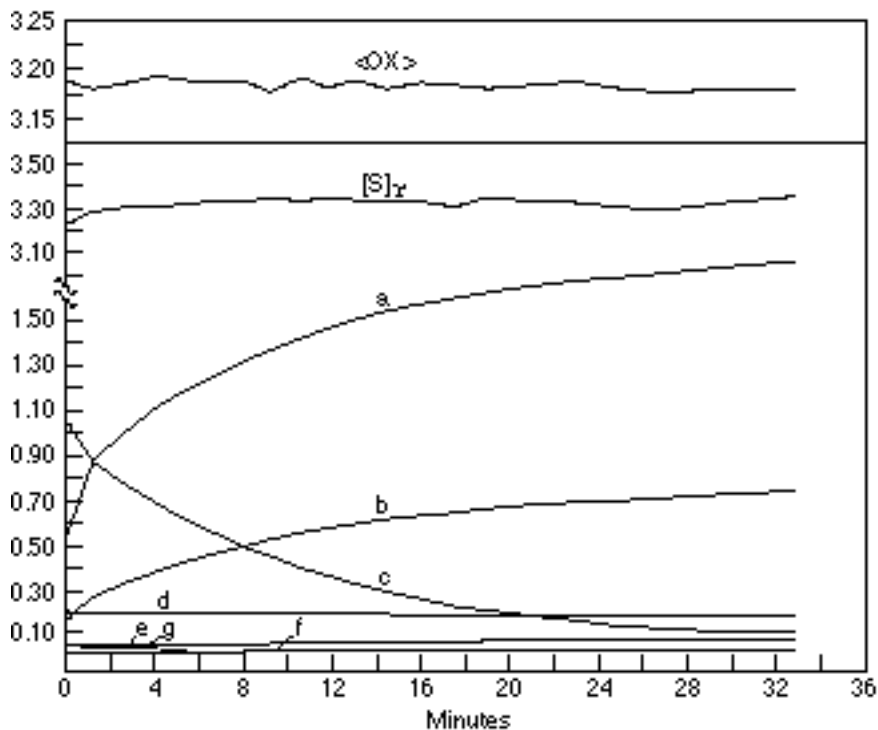

Figure 15.17 Multicomponent analysis of sulfur oxygen anions over a 30-min reaction period of the anaerobic aqueous decomposition of sodium dithionite. (a) $[\text{HSO}_3^-]$, (b) $[\text{S}_2\text{O}_3^{2-}]$, (c) $[\text{S}_2\text{O}_4^{2-}]$, (d) $[\text{S}_3\text{O}_6^{2-}]$, (e) $[\text{SO}_4^{2-}]$, (f) $[\text{S}_2\text{O}_5^{2-}]$, (g) $[\text{SO}_3^{2-}]$, $\langle\text{OX}\rangle$ = average oxidation state, and $[\text{S}]_T$ = total sulfur. (Reprinted with permission from D. A. Holman, A. W. Thompson, D. W. Bennett and J. D. Otvos, *Analytical Chemistry*, Vol. 66, No. 9, 1378–1384. Copyright 1994 American Chemical Society.)



4. Qualitative Analysis of Multilayered Polymeric Films using FTIR Microspectroscopy.

IR analysis can be used to determine the identities of polymer materials in a multilayered film. Using FTIR microspectroscopy, various layers in the polymeric film can be quickly characterized. The qualitative analysis of a three-layer, 20- μm -thick film is described below to demonstrate such an application (8).

The layered thin film is cut as a 2 \times 20-mm sheet. Cross-sections of the film are obtained using a fiber microtome. The individual section is transferred to a NaCl window on a slide positioned on the microscope stage. FTIR spectra are recorded in the transmission mode.

This particular sample has a three-layer composition of Primacor (8 μm), nylon (10 μm), and Primacor (8 μm). Primacor is a copolymer of ethylene and acrylic acid. Nylon is a polyamide polymer. Using an FTIR microscope, infrared transmittance spectra of the multilayered film are obtained (Fig. 15.22). An IR spectrum of pure Primacor can be obtained on the exposed outside layer. The IR spectrum of the center layer exhibits the contributions from both nylon and Primacor. This probably results from spatial contamination, which occurs when a specific layer of 8 to 10 μm or thinner is not masked properly for IR spectrum acquisition due to the poor contrast between the layers or the limitations of the aperture sizes. Functional group mapping can be performed to enhance the spatial resolution. This

Figure 15.18 Optical diagram of a diffuse reflectance accessory. (Reprinted by permission of Harrick Scientific Corporation.)

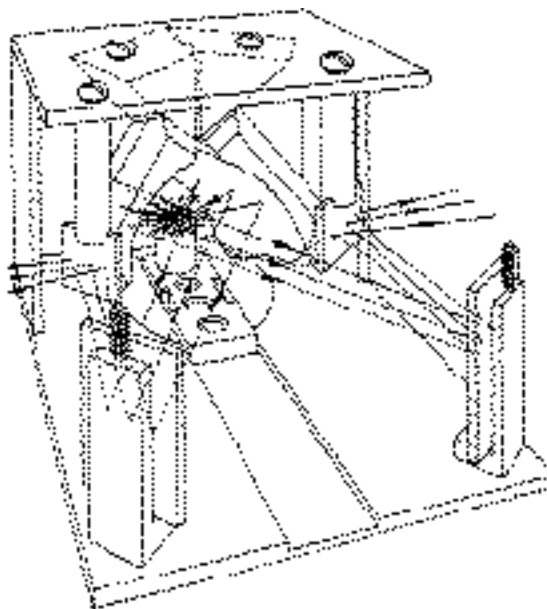
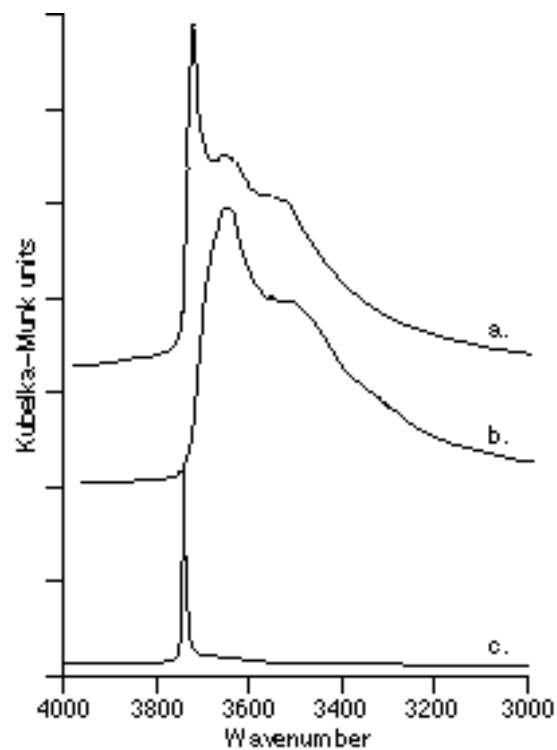

Figure 15.19 FTIR diffuse reflectance spectra of silica gel samples. (a) 200 °C pretreated silica, (b) HMDS pretreated silica, and (c) 600 °C pretreated silica. (Reprinted by permission from Spectroscopy, Vol. 9, No. 8 by J. P. Blitz and S. M. Augustine, © 1994 by Advantstar)



is accomplished by driving microscope stages across the film cross-section while mapping the concentration of functional groups that represent characteristics of each component. This type of infrared imaging technique can be more effectively carried out with a computer-controlled, two-dimensional motorized stage and provides a systematic, nondestructive evaluation of sample composition on a microscopic scale.

Nuts and Bolts

Relative Costs

Dispersive	\$\$ to \$\$\$
FT	\$\$\$ to \$\$\$\$
GCIR	\$\$\$
PAS	\$\$\$
IR microscope	\$\$ to \$\$\$
Reference spectra	\$ to \$\$

Figure 15.20 Chemical reactions of modified silica gel surfaces. (a) Before TiCl_4 reaction and (b) after TiCl_4 reaction. (Reprinted by permission from Spectroscopy, Vol. 9, No. 8 by J. P. Blitz and S. M. Augustine, © 1994 by Advanstar Communications.)

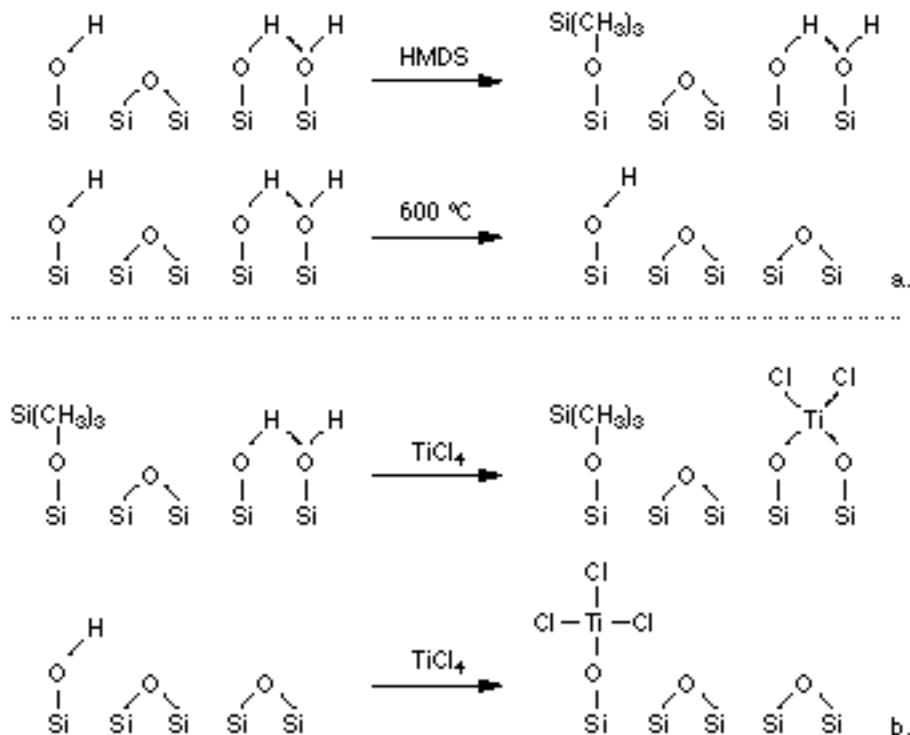

Maintenance 10% of purchase price per year
 Supplies <\$
 \$=1 to 5K, \$\$=5 to 15K, \$\$\$= 15 to 50K, \$\$\$\$=50 to 100K, \$\$\$\$\$=>100K.

The major factor affecting the cost of an IR spectrometer is its resolution. Resolution can range from 16 cm^{-1} to 0.1 cm^{-1} . The more expensive (\$\$\$\$), higher-resolution (0.1 cm^{-1}) instruments are used to resolve the vibrational bands into their rotational components. These instruments are used in research laboratories to obtain detailed structural information and physical constants for compounds. The lower-priced (\$\$\$), medium-resolution ($4\text{ to }2\text{ cm}^{-1}$) instruments are adequate for most analyses described here.

Vendors for Instruments and Accessories

Instruments

Nicolet Instrument Corp.
 5225 Verona Rd.
 Madison, WI 53711-4495
 phone: 800-232-1472, 608-276-6100
 fax: 608-273-5046
 email: nicinfo@nicolet.com
 Internet: <http://www.nicolet.com>

Figure 15.21 FTIR diffuse reflectance spectra of silica samples. Spectra before and after TiCl_4 treatment of 200 °C pretreated silica and the difference spectrum resulting from spectral subtraction are shown. (Reprinted from *Colloids and Surfaces*, 63, J. P. Blitz, pp. 11–19, copyright 1992, with kind permission from Elsevier Science—NL, Sara Burgerhartstraat 25, 1055 KV Amsterdam, The Netherlands.)

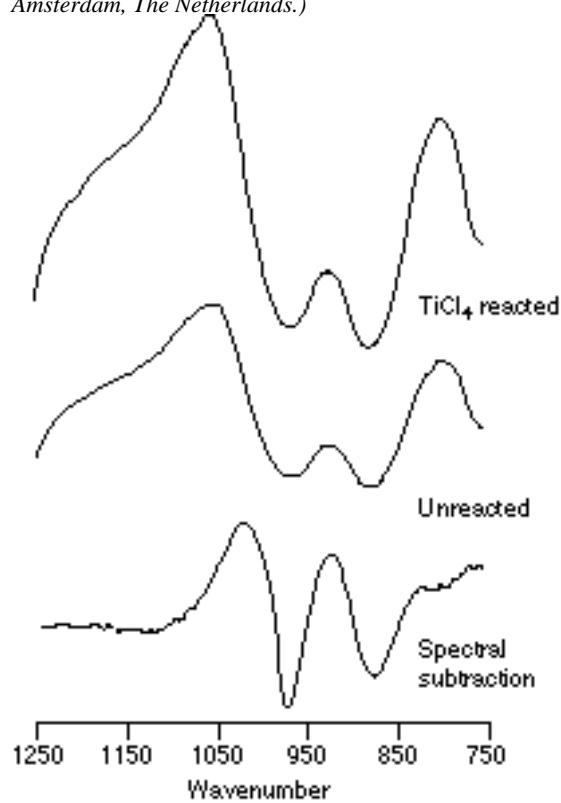
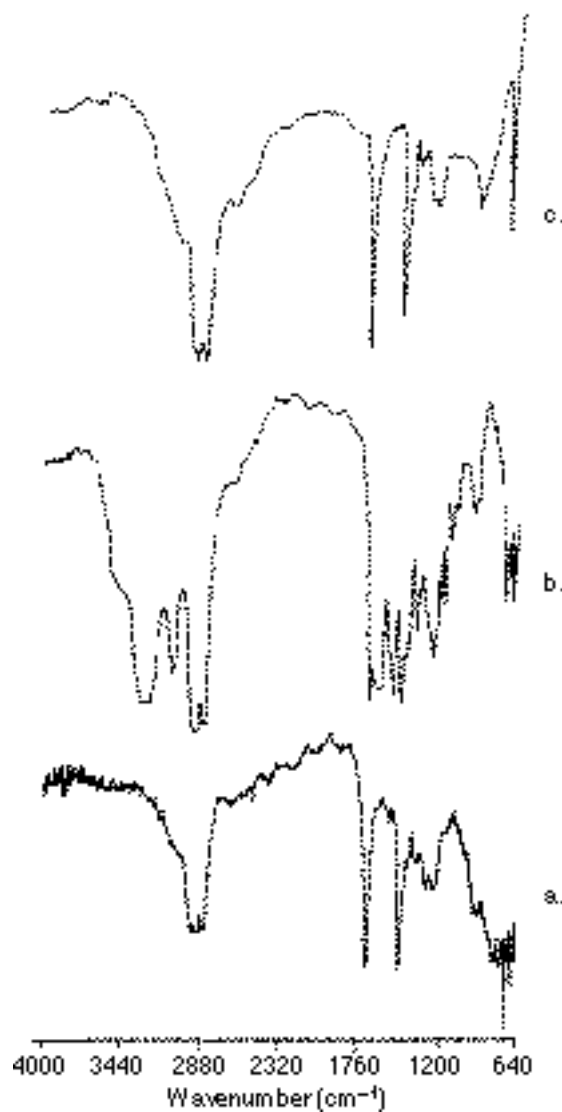

Figure 15.22 FTIR transmittance spectra of a film with a three-layer composition (Primacor–nylon–Primacor). (a) Outer layer, (b) center layer, and (c) Primacor standard. (Reprinted by permission from *Spectroscopy*, Vol. 8, No. 8 by T. I. Shaw, F. S. Karl, A. Krishen and L. E. Porter, ©1993 by Advanstar Communications.)



The Perkin-Elmer Corp.
 761 Main Ave.
 Norwalk, CT 06859-0012
 phone: 800-762-4000
 fax: 203-761-2882
 email: info@perkin-elmer.com

Internet: <http://www.perkin-elmer.com>

Bio-Rad Labs., Digilab Division
237 Putnam Ave.
Cambridge, MA 02139
phone: 800-225-1248
fax: 617-234-7045
email: sales.digilab@bio-rad.com

Bruker Instruments Inc.
19 Fortune Dr.
Billerica, MA 01821
phone: 508-667-9580, 888-427-8537
fax: 508-663-9177
email: optics@bruker.com
Internet: <http://www.bruker.com>

Mattson Instruments
5225 Verona Rd.
Madison, WI 53717-4495
phone: 800-423-6641, 608-276-6300
fax: 608-273-6818
email: info@mattsonir.com
Internet: <http://www.mattsonir.com>

Bomen Inc.
450 St. Jean Baptiste
Quebec, G2E 5S5, Canada
phone: 418-877-2944
fax: 418-877-2834

Most instrument manufacturers listed above also provide sampling accessories for their IR spectrometers.

Accessories

Spectra-Tech Inc.
2 Research Dr.
P.O. Box 869
Shelton, CT 06484-0869
phone: 203-926-8998
fax: 203-926-8909

The Perkin-Elmer Corp.
761 Main Ave.
Norwalk, CT 06859-0012
phone: 800-762-4002
fax: 203-761-9645

Harrick Scientific Corp.
88 Broadway
Box 1288

Ossining, NY 10562
phone: 914-762-0020, 800-248-3847
fax: 914-762-0914

International Crystal Laboratories
11 Erie St.
Garfield, NJ 07026
phone: 201-478-8944
fax: 201-478-4201

The Foxboro Company
600 N. Bedford St.
P.O. Box 500
East Bridgewater, MA 02333
phone: 508-378-5400
fax: 508-378-5202
email: tblom@foxboro.com
Internet: <http://www.foxboro.com>

Axiom Analytical Inc.
17751 Sky Park Circle, #ABC
Irvine, CA 92714
phone: 714-757-9300, 800-Go-Axiom
fax: 714-757-9306
email: goaxiom@aol.com
Internet: <http://www.goaxiom.com/axiom>

Graseby Specac Inc.
500 Technology Ct.
Smyrna, GA 30082-5210
phone: 770-319-9999, 800-447-2558
fax: 770-319-2488
email: specacusa@aol.com

Wilmad Glass Company, Inc.
Rt. 40 & Oak Rd.
Buena, NJ 08310
phone: 609-697-3000, 800-220-5171
fax: 609-697-0536
email: cs@wilmad.com
Internet: <http://www.wilmad.com>

Buck Scientific, Inc.
58 Fort Point St.
East Norwalk, CT 06855-1097
phone: 203-853-9444, 800-562-5566
fax: 203-853-0569
email: 102456.1243@compuserve.com
Internet: http://ourworld.compuserve.com/homepages/Buck_Scientific

Required Level of Training

Operation of Instrument

Routine analyses can be performed by analysts with a high school education or an associate college degree. A knowledge of the chemistry of the sample material is useful. Preparation of more difficult samples is an art gained through experience.

Processing Qualitative and Quantitative Data

Qualitative interpretation of spectra requires a minimum of a college organic chemistry course. Quantitative determinations require a minimum of an introductory analytical chemistry course.

Service and Maintenance

Most current spectrometers have diagnostic software that checks the instrument periodically and assists the operator in troubleshooting. The identification and replacement of faulty components are facilitated by the modular design of instrument systems. A high percentage of problems can be solved by trained laboratory personnel, thus eliminating the need for expensive visits by the vendors' engineers. The major components requiring replacement are sources and detectors. The sources for dispersive instruments (Nernst glowers and globar heaters) are much more expensive than the nichrome coil source commonly used with FTIR. However, the replacement of the helium neon laser source used for timing operations in an FTIR spectrometer is expensive (over \$600). The beamsplitter of a FT instrument is quite costly (over \$3,000). All types of detectors are expensive (over \$1000).

Suggested Readings

Books

- Annual Book of ASTM Standards*, vol. 03.06. Philadelphia: American Society for Testing and Materials, 1995.
- GRIFFITHS, P. R., AND J. A. DE HASETH, *Fourier Transform Infrared Spectrometry*. New York: Wiley, 1986.
- SILVERSTEIN, R. M., G. C. BASSLER, AND T. C. MORRILL, *Spectrometric Identification of Organic Compounds*, 5th ed. New York: Wiley, 1988.
- SMITH, A. L., *Applied Infrared Spectroscopy*. New York: Wiley, 1979.
- WILLARD, H. H., AND OTHERS, *Instrumental Methods of Analysis*, 7th ed. Belmont, CA: Wadsworth, 1987.

Articles

- BERGLUND, R. A., P. B. GRAHAM, AND R. S. MILLER, "Applications of In-situ FT-IR in Pharmaceutical Process R&D," *Spectroscopy*, 8, no. 8 (1993), 31.
- COATES, J. P., J. M. D'AGOSTINO, AND C. R. FRIEDMAN, "Quality Control Analysis by Infrared Spectroscopy, Part 1: Sampling," *American Laboratory*, 18, no. 11 (1986), 82.
- COATES, J. P., J. M. D'AGOSTINO, AND C. R. FRIEDMAN, "Quality Control Analysis by Infrared Spectroscopy, Part 2: Practical Applications," *American Laboratory*, 18, no. 12 (1986), 40.
- CROOKS, R. M., AND OTHERS, "The Characterization of Organic Monolayers by FT-IR External Reflectance Spectroscopy," *Spectroscopy*, 8, no. 7 (1993), 28.
- FUJIMOTO, C., AND K. JINNO, "Chromatography/FT-IR Spectrometry Approaches to Analysis," *Analytical Chemis-*

try, 64 (1992), 476A.

- HARIS, P. I., AND D. CHAPMAN, "Does Fourier Transform Infrared Spectroscopy Provide Useful Information on Protein Structures?" *Trends Biochemical Sciences*, 17, no. 9 (1992), 328.
- JONES, R. W., AND J. F. MCCLELLAND, "Transient IR Spectroscopy: On-line Analysis of Solid Materials," *Spectroscopy*, 7, no. 4 (1992), 54.
- KATON, J. E., AND A. J. SOMMER, "IR Microspectroscopy: Routine IR Sampling Methods Extended to Microscopic Domain," *Analytical Chemistry*, 64 (1992), 931A.
- KOENIG, J. L., "Industrial Problem Solving with Molecular Spectroscopy," *Analytical Chemistry*, 66 (1994), 515A.
- SPELLICY, R. L., AND OTHERS, "Spectroscopic Remote Sensing: Addressing Requirements of the Clean Air Act", *Spectroscopy*, 6, no. 9 (1991), 24.
- WARR, W. A., "Computer-Assisted Structure Elucidation, Part 1: Library Search and Spectral Data Collections," *Analytical Chemistry*, 65 (1993), 1045A.

Training Aids

- Audio/video courses: Both audio and video training courses of IR spectroscopy are available from American Chemical Society.
- Programmed learning book: GEORGE, W. O., AND P. S. MCINTYRE, *Infrared Spectroscopy*, Analytical Chemistry by Open Learning Project, D. J. Mowthorpe, ed. New York: Wiley, 1987.
- Short courses: A number of short courses and workshops are generally held in conjunction with American Chemical Society National Meeting, Pittsburgh Conference and Eastern Analytical Symposium. The subjects covered include interpretation of IR spectra, sampling techniques, and accessories. Chemistry short courses of IR spectroscopy are also offered by the Center for Professional Advancement (East Brunswick, N.J.), Chemistry Department of Miami University (Oxford, OH), and Spectros Associates (Northbridge, MA).
- Software: IR Mentor, a software aid to spectral interpretation, is available from Sadtler Division, Bio-Rad Laboratories, Inc.

Reference Spectra

- Aldrich Chemical Company, Inc.: 17,000 Aldrich-Nicolet FTIR spectra in hard-copy reference books or electronic databases and 12,000 IR spectra in hard-copy books.
- Sadtler Division of Bio-Rad Laboratories: More than 150,000 spectra in over 50 different electronic databases, or 89,000 spectra in 119 volumes of hard-copy handbooks.
- Sigma Chemical Company: 10,400 FTIR spectra of biochemicals and related organics in hardbound books.
- The U.S. Environmental Protection Agency (EPA) vapor phase database (3240 FTIR spectra), Canadian forensic database (3490 spectra), Georgia State Crime Lab database (1760 spectra), and other spectral collections are available through instrument manufacturers.

References

1. An HPLC/FTIR interface is available commercially from Lab Connections, Inc., Marlborough, MA.
2. D. R. Lide, ed., *CRC Handbook of Chemistry and Physics*, 75th ed. (Boca Raton, FL: CRC Press, 1994), 9-79.
3. R. M. Silverstein, G. C. Bassler, and T. C. Morrill, *Spectrometric Identification of Organic Compounds*, 4th ed. (New York: Wiley, 1981), 166.
4. U.S. Environmental Protection Agency, *Methods for Chemical Analysis of Water and Wastes*, 3rd ed., Report No. EPA-600/4-79-020 (Springfield, VA: National Technical Information Service, 1983), 413.2-1, 418.1-1.

5. D. A. Holman and others, *Analytical Chemistry*, 66 (1994), 1378.
6. J. P. Blitz and S. M. Augustine, *Spectroscopy*, 9, no. 8 (1994), 28.
7. J. P. Blitz, *Colloids and Surfaces*, 63 (1992), 11.
8. T. I. Shaw and others, *Spectroscopy*, 8, no. 8 (1993), 45.

Acknowledgment

The author is grateful to Prof. Frank A. Settle, Jr. for providing the detailed handbook template based on infrared spectroscopy. The author would also like to thank Dr. Paul A. Bouis, Prof. Roland W. Lovejoy, and Barbara K. Barr for helpful suggestions and critical reviews of the manuscript.

